



ETI d.d.
1411 Izlake, Slovenija
Obrezija 5

Telefon: +386 (0)3 56 57 570
Fax: +386 (0)3 56 74 077
www.eti.si

LIMAT2-SD,
LIMAT2-DN,
LIMAT4-SD,
LIMAT4-DN,
DIFO2,
DIFO2-DN,
DIFO4,
DIFO4-DN

Navodilo za montažo in uporabo

SLO

ZAŠČITNO STIKALO NA DIFERENČNI TOK Z VGRAJENO NADTOKOVNO ZAŠČITO LIMAT

Za preprečitev električnega udara mora biti:

- zaščitno stikalo montirano in servisirano samo s strani pooblaščenih oseb,
- izklopljeno glavno in pomožno napajanje zaščitnega stikala, zaradi kakršnega koli posega na stikalo,
- neprisotnost napetosti vedno preveriti z ustreznim instrumentom,
- pred vklopom zaščitnega stikala v omrežje preveriti vse povezave in zaščite.

1. MONTAŽA

Zaščitno stikalo z nadtokovno zaščito LIMAT se lahko uporablja v TN-S, TN-C-S, TT in IT sistemih omrežja, torej povsod tam, kjer zaščitni in ničelni vodnik nista povezana.

LIMAT je namenjen montaži na nosilno letev 35 mm po EN 60715.

2. PRIKLJUČEVANJE

Način priključitve in notranje povezave so prikazane na skici A. Dovod je lahko zgoraj ali spodaj.

3. TEHNIČNI PODATKI

Nazivna napetost U_n	~230 V (2p), ~400V (4p)
Nazivni tok I_n	6-50 A
Nazivni diferenčni tok $I_{\Delta n}$	30 mA, 100 mA, 300 mA
Tip	A, AC
Izklopna karakteristika	B, C
Nazivna kratkostična zmogljivost I_{cn}	10.000 A
Nazivna frekvenca f_n	50 Hz
Razred selektivnosti	3
Presek priključnih vodnikov	1 – 25 mm ²
Standardi	IEC 61009, EN 61009, SIST EN 61009, LV in EMC direktiva

4. MAKSIMALNE VREDNOSTI OZEMLJITVENIH UPORNOSTI

U_e^*	R_e max						Ω
	50 V ~			25 V ~			
$I_{\Delta n}$	0,03	0,1	0,3	0,03	0,1	0,3	A
R_e	1660	500	166	830	250	83	

U_e^* - napetost dotika

Izklopni čas < 0,3 s.

5. DELOVANJE

Pogoji za pravilno delovanje zaščitnega stikala:





- linijski (fazni) vodnik in nevtralni vodnik morata biti vodena skozi zaščitno stikalo;
- N-vodnik mora biti za stikalom izoliran enako kot linijski vodnik, sicer lahko prihaja do napačnih oz. neželenih proženj;
- ozemljitvene upornosti ne smejo presežati predpisanih vrednosti;
- najprej je potrebno vklopiti desni gumb (diferenčna zaščita), šele nato je možno vklopiti gumbe na inštalacijskem odklopniku (2p oziroma 4p inštalacijski odklopnik ETIMAT6 ali ETIMAT10);
- če pride do napake zaradi preobremenitve ali kratkega stika, izklopi samo inštalacijski odklopnik ETIMAT (gumbi na ETIMAT-u), gumb na diferenčnem delu ostane vklopljen;

- če pride do napake zaradi diferenčnega toka, diferenčni del izklopi tudi inštalacijski odklopnik ETIMAT, kar pomeni da so izklopljeni vsi gumbi;
- LIMAT2-DN in LIMAT4 -DN (nadnapetostni modul), pri vseh definiranih napakah (razen preobremenitve in kratkega stika) izklopijo vsi gumbi.
- LIMAT-DN: pomembna je pravilna priključitev priključnih vodnikov (v skladu s shemo – skica A):
 - desna spodnja sponka: NIČELNI VODNIK (dovod);
 - leva spodnja sponka (leve tri spodnje sponke): LINIJSKI (FAZNI) VODNIK (I) (dovod);
 - desna zgornja sponka: NIČELNI VODNIK (izhod);
 - leva zgornja sponka (leve tri zgornje sponke): LINIJSKI (FAZNI) VODNIK (I) (izhod);
 - dodatni vodnik (rumeno-zeleni): OZEMLJITVENI vodnik.

Delovanje nadnapetostnega modula:

- izklop pri nadnapetosti 270±10 V v kateri koli fazi, t_{off} = max. 200 ms,
- ne izklopi pri fazni nadnapetosti 300V in trajanju ≤ 50 ms,
- izklop pri pojavu napetosti na ničelnem vodniku 45±5 V (U_{PE-N}),
- izklop v primeru prekinitve zaščitnega (PE) vodnika,
- izklop v primeru prekinitve ničelnega (N) vodnika,
- skozi priključni ozemljitveni vodnik ne sme teči tok večji od 5 mA.

Signalizacija:

 PE , L – N	prekinitev zaščitnega vodnika (PE) ali zamenjava faznega in ničelnega vodnika (L in N), sledi izklop
 >270 V,  45±5 V (U_{PE-N})	pojav nadnapetosti v katerikoli fazi (>270 V) ali napetosti na ničelnem vodniku 45±5V (U_{PE-N}), sledi izklop
 N	prekinitev ničelnega vodnika (N), sledi izklop, po ponovni priključitvi ničelnega vodnika signalizacija ugasne

Pomen simbolov:

-  - sveti
-  - ne sveti

6. PRESKUS DELOVANJA STIKALA S TESTNO TIPKO

Vsaj enkrat na pol leta je potrebno pritisniti testno tipko T. Zaščitno stikalo mora izklopiti.

7. RAZLAGA SIMBOLOV NA STIKALU

-  L-N Zaščitno stikalo za sinusne izmenične in pulzirajoče enosmerne diferenčne toke, tip A.

-  Zaščitno stikalo za sinusne izmenične diferenčne toke, tip AC.

SKICA A: NOTRANJE POVEZAVE

SKICA B: DIMENZIJE

Installation and user manual

EN

Residual Current Circuit Breakers with Integral Overcurrent Protection LIMAT

To prevent the risk of electric shock:

- the device should only be installed and serviced by professionals
- switch off the general and auxiliary power supply to the device prior to any work on or in the device
- always use an appropriate voltage detection device to confirm the absence of voltage
- replace all interlocks, doors and covers before energising the device.

1. MOUNTING

Residual current operated circuit breaker with overcurrent protection (RCBO) can be used in TN-S, TN-C-S, TT and IT network systems which means in all places where neutral and protective conductor are not connected.

RCBO shall be mounted onto a rail of 35 mm according to EN 60715.

2. CONNECTION

Connections and internal connections are shown in figure A. The supply can be above or below.

3. TECHNICAL DATA

Rated voltage U_n	~230 V (2p), ~400 V (4p)
Rated current I_n	6-50A
Rated residual current $I_{\Delta n}$	30 mA, 100 mA, 300 mA
Type	A, AC
Tripping characteristic	B, C
Rated short-circuit capacity	10.000 A
Rated frequency f_n	50Hz
Energy limiting class	3
Cross section of connecting lead	1 – 25 mm ²
Standards	IEC 61009, EN 61009, SIST EN 61009, LV in EMC directive

4. MAXIMUM VALUES OF EARTHING RESISTANCE

U_e^*	R_e max						Ω
	50 V ~			25 V ~			
$I_{\Delta n}$	0,03	0,1	0,3	0,03	0,1	0,3	A
R_e	1660	500	166	830	250	83	

U_e^* - touch voltage

Break time < 0,3 s.

5. OPERATION

The conditions for correct operation of the RCBO:





- the line (phase) conductor and the neutral conductor shall be conducted through the RCBO;
- the neutral conductor shall be behind the breaker insulated in the same way as the line (phase) conductor, otherwise there can appear false or unwanted tripping;
- earthing resistances shall not exceed the prescribed values;
- switching on – the right switching handle (residual current protection) should be switched on first and then the left one (miniature circuit breaker);
- switching off:
 - overcurrent or short-circuit current fault - the left switching handle off position, the right one stays in on

- position:
 - residual current fault – both switching handles are switched off;
- LIMAT2-DN and LIMAT4_DN (overvoltage module) – in all defined faults both switching handles are switched off (except in case of overcurrent or short-circuit current)
- LIMAT-DN: right connection of conductors is very important (see Figure A):
 - the right lower terminal: NEUTRAL (N) conductor (supply);
 - the left lower terminal (left lower three terminals): LINE (PHASE) CONDUCTOR(S) (supply);
 - the right upper terminal: NEUTRAL (N) conductor (load);
 - the left upper terminal (left upper three terminals): LINE (PHASE) CONDUCTOR(S) (load);
 - the additional conductor (yellow/green) must be connected to protective earth (PE) conductor.



Additional functions of overvoltage module:

- switching off at overvoltage value of 270±10 V in any phase t_{off} = max. 200 ms,
- no switching off at overvoltage of 300 V in duration ≤ 50ms,
- switching off in case of neutral conductor voltage exceeding 45±5V (U_{PE-N}),
- switching off if protective earth (PE) conductor is interrupted,
- switching off if neutral (N) conductor is interrupted,
- switching off in case of wrong phase and neutral connection,
- the current through the protective earth conductor should not be higher than 5 mA.

Signalisation:

 PE , L – N	PE conductor is interrupted or misconnection of line (L) and neutral (N) conductor, RCBO switch off
 >270 V,  45±5 V (U_{PE-N})	overvoltage of 270V±10V in any phase or neutral conductor voltage 45±5V (U_{PE-N}), RCBO switch off
 N	neutral conductor (N) is interrupted, RCBO switch off, after re-connection of neutral conductor signalling switch off

Meaning of symbols:

-  - light emission
-  - no light emission

6. TESTING OF BREAKER OPERATION WITH THE TEST BUTTON

At least once in a half year the test button shall be actuated. RCBO must switch off.

7. EXPLANATION OF THE SYMBOLS ON THE BREAKER

-  L-N RCBO for residual sinusoidal alternating and residual pulsating direct currents, Type A.

-  RCBO for residual sinusoidal alternating currents, Type AC.

FIGURE A: THE INTERNAL CONNECTIONS

FIGURE B: DIMENSIONS

A:

DIF02

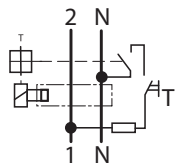

DIF02-DN

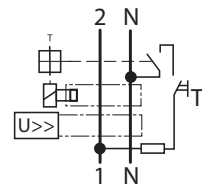

LIMAT2-SD

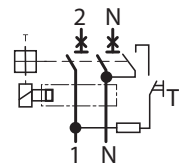

LIMAT2-DN

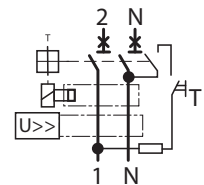

DIF04

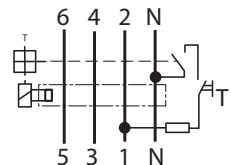

DIF04-DN

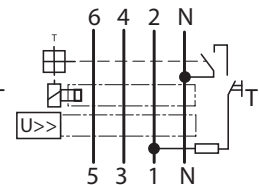

LIMAT4-SD

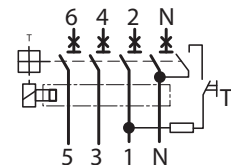

LIMAT4-DN

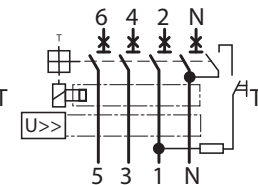

B: DIF02

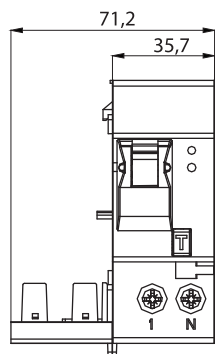

LIMAT2-SD

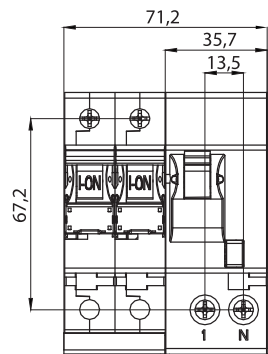

DIF04

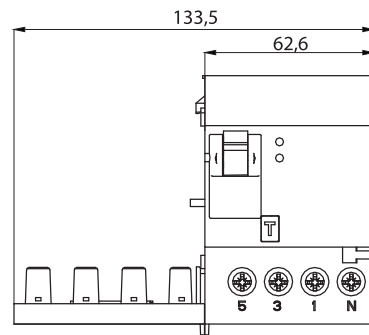

LIMAT4-SD

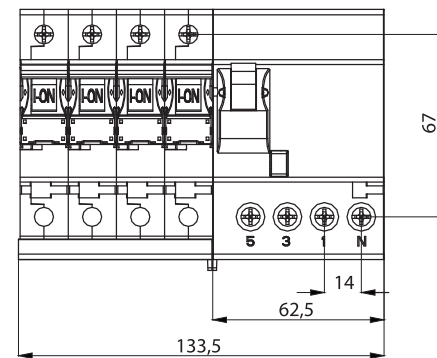

LIMAT2-SD
LIMAT2-DN
LIMAT4-SD
LIMAT4-DN

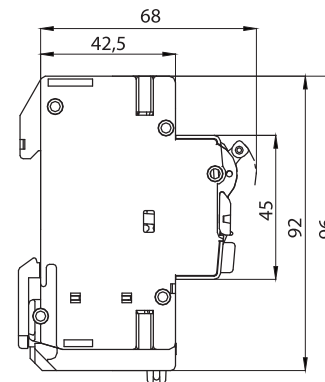

DIF02-DN

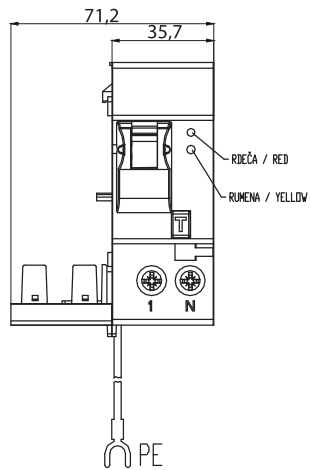

LIMAT2-DN

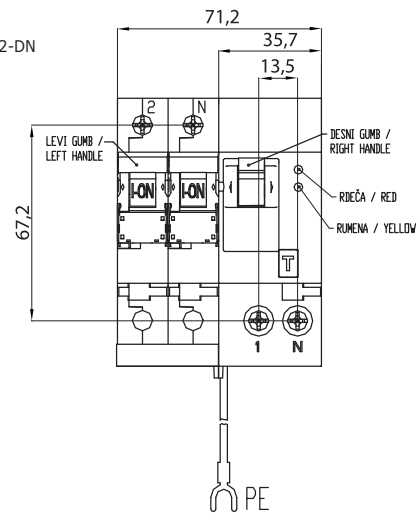

DIF04-DN

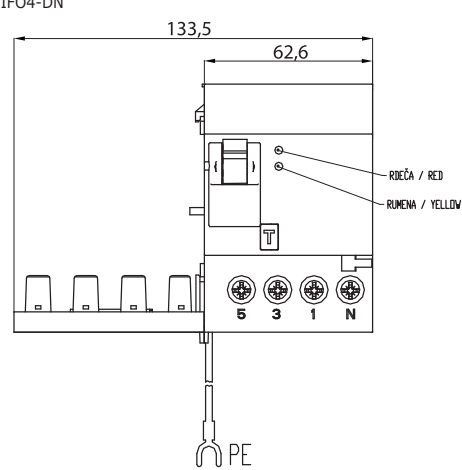

LIMAT4-DN

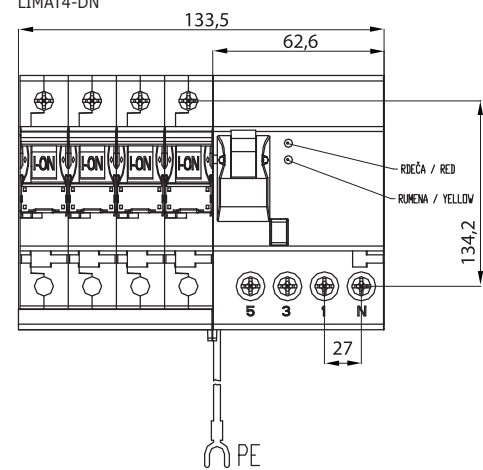

DIF02
DIF02-DN
DIF04
DIF04-DN

