

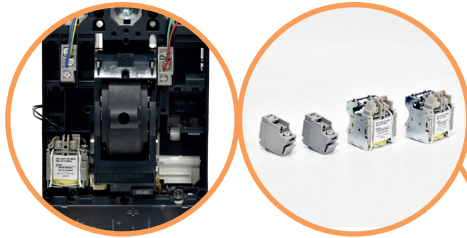

# Low voltage moulded case circuit breakers ETIBREAK NBS

ETIBREAK



→ All Auxiliary and Alarm Contacts can be used for all Frame Sizes up to 1600A. There are two different types of SHT and UVT:

- first type can be used for Frame Sizes 100-630A
- second type can be used for Frame Size 1600A

→ NBS-TMS series of MCCB can be adjusted between 0,8 - 1,0 x In, meanwhile short-circuit protection is fixed at value of 10 x In.

→ NBS-TMD series of MCCB can be adjusted between 0,8 - 1,0 x In for Frame Sizes up to 250A and between 0,7 - 1,0 x In for Frame Sizes from 315A and up to 630A. Short-circuit protection can be adjusted between 5 - 10 x In.



Microprocessor breakers NBS-E 100, 160, 250, 400, 630 have a standard LSI adjustment dial:  
 L - Overload protection  
 S - Delayed short circuit protection  
 I - Instantaneous protection

Microprocessor breakers NBS-E 1600 have LI protection relay:  
 L - Overload protection  
 I - Instantaneous protection

Standard Frame Sizes

NBS 100 & 160 & 250

NBS 400 & 630

NBS 1600

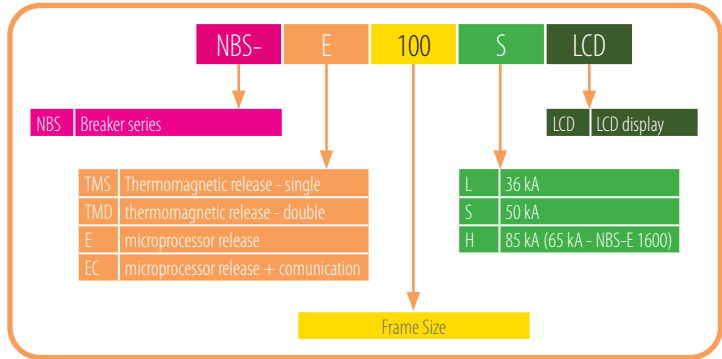

→ All data on the front side of the breaker are laser printed.

→ NBS-E LCD microprocessor electronic trip units have LSI trip unit with overload protection adjustment, adjustment of protection against short circuit (current and time) and adjustment of instantaneous short circuit current.

→ In this unit is provided the possibility of turning off protective devices functions and using automatic switch as a Switch disconnector.

→ NBS-EC LCD microprocessor electronic trip units have LSI trip unit with overload protection adjustment, adjustment of protection against short circuit (current and time) and adjustment of instantaneous short circuit current, RS-485 communication port, source microprocessor power supply.



In addition, **NBS-EC LCD** have additional protection functions:  
 - protection against high and low voltage; protection against disconnection, asymmetry and change of phases; control of increased and decreased frequency; temperature control and protection against overheating, etc. All protection functions have 3 modes of operation:

**Trip** – the protection function is activated. In case of exceeding control values AB turns off;

**Alarm** - LED alarm is on. When the control values are exceeded the red LED starts flashing;

**OFF** - the protection functions and indications are disabled.

Also, in this release, it is possible to turn off the protection functions and the use of a circuit breaker as a Switch disconnector.



→ Indication on the breaker and the handle shows the status "ON" / "OFF" or "TRIP"

Advantages and features of low voltage MCCB ETIBREAK NBS

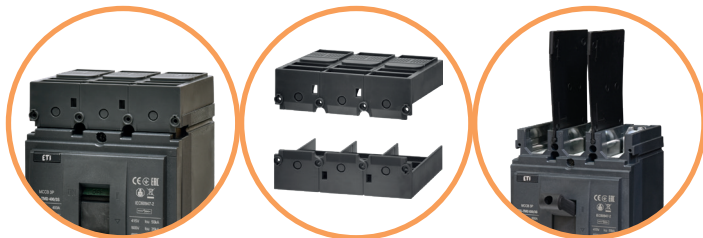

→ The risk of touching live parts has been minimised to minimum by:

- terminal protection covers,
- interpole barriers provide maximum insulation between phases at the terminals

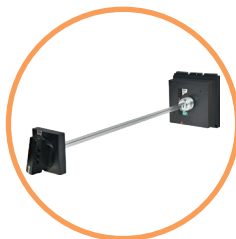

→ The door mounted handles allow breakers installed in cabinets to be manually operated from outside.

→ Adjustment dials are covered with transparent cover, which has the possibility of sealing.

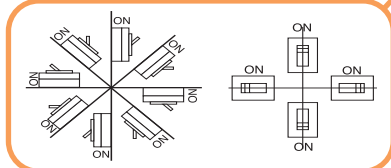

→ ETIBREAK NBS circuit breakers can be mounted at any angle without affecting performance.

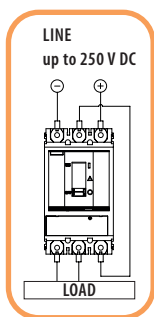

→ NBS-TMS and NBS-TMD series of MCCB's can be used in systems with DC voltage up to 250V.

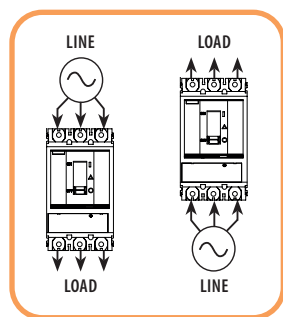

→ Power can be supplied through NBS-TMS, NBS-TMD or NBS-E, NBS-E LCD in either direction without loss of performance.

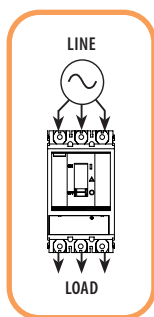

→ Power can be supplied through NBS-EC LCD only from the top.

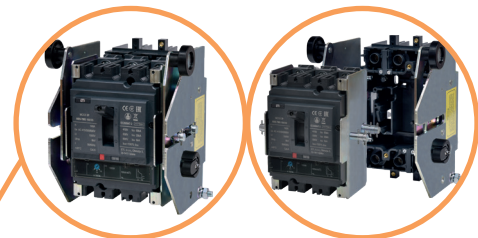

→ Plug-in and Draw-out version of breaker allows easy replacement of breaker without the need to disturb the termination.



→ Marking plate on the breaker body indicates minimum and maximum value of the MCCB current



→ Motor operator provide the possibility of remote ON/OFF function of MCCB.



For connecting flexible (multicore) conductors NBS-TC clamps are used. To connect compression terminals or flat bars special NBS-ZB Extension bars can be used.

Low voltage moulded case circuit breakers ETIBREAK NBS

Low voltage moulded case circuit breakers are used for the switching and protection of power supply cables, motors and other electrical equipment against overloads and short circuit faults.

Technical data	
Frame Size ETIBREAK NBS	100&160&250, 400&630, 1600
Nominal currents	20 - 1600A
Number of poles	3 & 4
Rated impulse withstand voltage $U_{imp}$	8 kV
Rated insulation voltage $U_i$	1000 V
Ultimate breaking capacity $I_{cu}$	36 - 85 kA
Standards	IEC 60947-2, EN 60947-2

ETIBREAK NBS-TMS/TMD (L - 36kA, with thermomagnetic release)

ETIBREAK NBS-TMS (20..160A, 36kA)

ETIBREAK NBS-TMS 100/3L...4L (L - 36kA)										
Type	$I_N$ (A)	Code No.	Poles	$I_{cs}=I_{cu}$ 415V(kA)	Adjustment thermal/magnetic	Weight (kg)	Packaging (pcs)			
NBS-TMS 100/3L 20A 3P	20	004673001	3	36	(0,8...0,9...1)xln / 10xln	1,9	1			
NBS-TMS 100/3L 25A 3P	25	004673010				1,9	1			
NBS-TMS 100/3L 32A 3P	32	004673002				1,9	1			
NBS-TMS 100/3L 40A 3P	40	004673003				1,9	1			
NBS-TMS 100/3L 50A 3P	50	004673004				1,9	1			
NBS-TMS 100/3L 63A 3P	63	004673005				1,9	1			
NBS-TMS 100/3L 80A 3P	80	004673006				1,9	1			
NBS-TMS 100/3L 100A 3P	100	004673007				1,9	1			
NBS-TMS 100/4L 20A 4P	20	004673011				4	36	(0,8...0,9...1)xln / 10xln	2,15	1
NBS-TMS 100/4L 25A 4P	25	004673020							2,15	1
NBS-TMS 100/4L 32A 4P	32	004673012	2,15	1						
NBS-TMS 100/4L 40A 4P	40	004673013	2,15	1						
NBS-TMS 100/4L 50A 4P	50	004673014	2,15	1						
NBS-TMS 100/4L 63A 4P	63	004673015	2,15	1						
NBS-TMS 100/4L 80A 4P	80	004673016	2,15	1						
NBS-TMS 100/4L 100A 4P	100	004673017	2,15	1						



NBS-TMS 100/3L  
NBS-TMS 160/3L



NBS-TMD 250/3L



NBS-TMD 250/4L



NBS-TMD 400/4L

ETIBREAK NBS-TMS 160/3L...4L (L - 36kA)							
Type	$I_N$ (A)	Code No.	Poles	$I_{cs}=I_{cu}$ 415V(kA)	Adjustment thermal/magnetic	Weight (kg)	Packaging (pcs)
NBS-TMS 160/3L 125A 3P	125	004673008	3	36	(0,8...0,9...1)xln / 10xln	1,9	1
NBS-TMS 160/3L 160A 3P	160	004673009				1,9	1
NBS-TMS 160/4L 125A 4P	125	004673018	4	36	(0,8...0,9...1)xln / 10xln	2,15	1
NBS-TMS 160/4L 160A 4P	160	004673019				2,15	1

ETIBREAK NBS-TMD (200-250A, 36kA)

ETIBREAK NBS-TMD 250/3L ...4L (L - 36kA)							
Type	$I_N$ (A)	Code No.	Poles	$I_{cs}=I_{cu}$ 415V(kA)	Adjustment thermal/magnetic	Weight (kg)	Packaging (pcs)
NBS-TMD 250/3L 200A 3P	200	004673071	3	36	(0,8...0,9...1)xln / (5-10)xln	1,9	1
NBS-TMD 250/3L 250A 3P	250	004673072				1,9	1
NBS-TMD 250/4L 200A 4P	200	004673073	4	36	(0,8...0,9...1)xln / (5-10)xln	2,15	1
NBS-TMD 250/4L 250A 4P	250	004673074				2,15	1

ETIBREAK NBS-TMD (315-400A, 36kA)

ETIBREAK NBS-TMD 400/3L...4L (L - 36kA)							
Type	$I_N$ (A)	Code No.	Poles	$I_{cs}=I_{cu}$ 415V(kA)	Adjustment thermal/magnetic	Weight (kg)	Packaging (pcs)
NBS-TMD 400/3L 315A 3P	315	004673101	3	36	(0,7..0,8..0,9..1)xln / (5-10)xln	6,75	1
NBS-TMD 400/3L 400A 3P	400	004673102				6,75	1
NBS-TMD 400/4L 315A 4P	315	004673103	4	36	(0,7..0,8..0,9..1)xln / (5-10)xln	8,75	1
NBS-TMD 400/4L 400A 4P	400	004673104				8,75	1

## Low voltage moulded case circuit breakers ETIBREAK NBS

## ETIBREAK NBS-TMD (500-600A, 36kA)

**ETIBREAK NBS-TMD 630/3L...4L (L - 36kA)**

Type	I <sub>N</sub> (A)	Code No.	Poles	I <sub>cs</sub> =I <sub>cu</sub> 415V(kA)	Adjustment thermal/magnetic	Weight (kg)	Packaging (pcs)
NBS-TMD 630/3L 500A 3P	500	004673131	3	36	(0,7..0,8...0,9..1)xln/(5-10)xln	6,75	1
NBS-TMD 630/3L 600A 3P	600	004673132				6,75	1
NBS-TMD 630/4L 500A 4P	500	004673133	4	36	(0,7..0,8...0,9..1)xln/(5-10)xln	8,75	1
NBS-TMD 630/4L 600A 4P	600	004673134				8,75	1

## ETIBREAK NBS-TMS/TMD (S - 50kA, with thermomagnetic release)

## ETIBREAK NBS-TMS (20..160A, 50kA)

**ETIBREAK NBS-TMS 100/3S...4S (S - 50kA)**

Type	I <sub>N</sub> (A)	Code No.	Poles	I <sub>cs</sub> =I <sub>cu</sub> 415V(kA)	Adjustment thermal/magnetic	Weight (kg)	Packaging (pcs)
NBS-TMS 100/3S 20A 3P	20	004673021	3	50	(0,8...0,9...1)xln / 10xln	1,9	1
NBS-TMS 100/3S 25A 3P	25	004673030				1,9	1
NBS-TMS 100/3S 32A 3P	32	004673022				1,9	1
NBS-TMS 100/3S 40A 3P	40	004673023				1,9	1
NBS-TMS 100/3S 50A 3P	50	004673024				1,9	1
NBS-TMS 100/3S 63A 3P	63	004673025				1,9	1
NBS-TMS 100/3S 80A 3P	80	004673026				1,9	1
NBS-TMS 100/3S 100A 3P	100	004673027	4	50	(0,8...0,9...1)xln / 10xln	1,9	1
NBS-TMS 100/4S 20A 4P	20	004673031				2,15	1
NBS-TMS 100/4S 25A 4P	25	004673040				2,15	1
NBS-TMS 100/4S 32A 4P	32	004673032				2,15	1
NBS-TMS 100/4S 40A 4P	40	004673033				2,15	1
NBS-TMS 100/4S 50A 4P	50	004673034				2,15	1
NBS-TMS 100/4S 63A 4P	63	004673035				2,15	1
NBS-TMS 100/4S 80A 4P	80	004673036	2,15	1			
NBS-TMS 100/4S 100A 4P	100	004673037	2,15	1			

**ETIBREAK NBS-TMS 160/3S...4S (S - 50kA)**

Type	I <sub>N</sub> (A)	Code No.	Poles	I <sub>cs</sub> =I <sub>cu</sub> 415V(kA)	Adjustment thermal/magnetic	Weight (kg)	Packaging (pcs)
NBS-TMS 160/3S 125A 3P	125	004673028	3	50	(0,8...0,9...1)xln / 10xln	1,9	1
NBS-TMS 160/3S 160A 3P	160	004673029				1,9	1
NBS-TMS 160/4S 125A 4P	125	004673038	4	50	(0,8...0,9...1)xln / 10xln	2,15	1
NBS-TMS 160/4S 160A 4P	160	004673039				2,15	1

## ETIBREAK NBS-TMD (200-250A, 50kA)

**ETIBREAK NBS-TMD 250/3S...4S (S - 50kA)**

Type	I <sub>N</sub> (A)	Code No.	Poles	I <sub>cs</sub> =I <sub>cu</sub> 415V(kA)	Adjustment thermal/magnetic	Weight (kg)	Packaging (pcs)
NBS-TMD 250/3S 200A 3P	200	004673075	3	50	(0,8...0,9...1)xln / (5-10)xln	1,9	1
NBS-TMD 250/3S 250A 3P	250	004673076				1,9	1
NBS-TMD 250/4S 200A 4P	200	004673077	4	50	(0,8...0,9...1)xln / (5-10)xln	2,15	1
NBS-TMD 250/4S 250A 4P	250	004673078				2,15	1

## ETIBREAK NBS-TMD (315-400A, 50kA)

**ETIBREAK NBS-TMD 400/3S...4S (S - 50kA)**

Type	I <sub>N</sub> (A)	Code No.	Poles	I <sub>cs</sub> =I <sub>cu</sub> 415V(kA)	Adjustment thermal/magnetic	Weight (kg)	Packaging (pcs)
NBS-TMD 400/3S 315A 3P	315	004673105	3	50	(0,7..0,8...0,9..1)xln/(5-10)xln	6,75	1
NBS-TMD 400/3S 400A 3P	400	004673106				6,75	1
NBS-TMD 400/4S 315A 4P	315	004673107	4	50	(0,7..0,8...0,9..1)xln/(5-10)xln	8,75	1
NBS-TMD 400/4S 400A 4P	400	004673108				8,75	1

## ETIBREAK NBS-TMD (500-600A, 50kA)

**ETIBREAK NBS-TMD 630/3S...4S (S - 50kA)**

Type	I <sub>N</sub> (A)	Code No.	Poles	I <sub>cs</sub> =I <sub>cu</sub> 415V(kA)	Adjustment thermal/magnetic	Weight (kg)	Packaging (pcs)
NBS-TMD 630/3S 500A 3P	500	004673135	3	50	(0,7..0,8...0,9..1)xln/(5-10)xln	6,75	1
NBS-TMD 630/3S 600A 3P	600	004673136				6,75	1
NBS-TMD 630/4S 500A 4P	500	004673137	4	50	(0,7..0,8...0,9..1)xln/(5-10)xln	8,75	1
NBS-TMD 630/4S 600A 4P	600	004673138				8,75	1

 NBS-TMD 400/3L  
NBS-TMD 630/3L

 NBS-TMS 100/3S  
NBS-TMS 160/3S

NBS-TMS 100/4L



NBS-TMD 250/3S

 NBS-TMD 400/3S  
NBS-TMD 630/3S

ETIBREAK NBS-E (L - 36kA, S - 50kA, H - 65/85kA, with microprocessor release)

ETIBREAK NBS-E (100..1600A, 36kA)



NBS-E 100/3L ..3S ..3H  
NBS-E 160/3L ..3S ..3H  
NBS-E 250/3L ..3S ..3H

ETIBREAK

ETIBREAK NBS-E 100...250/3L...4L (L - 36kA)

Type	I <sub>N</sub> (A)	Code No.	Poles	I <sub>cs</sub> =I <sub>cu</sub> 415V(kA)	L (lr) / S (lsd) / I (li)	Weight (kg)	Packaging (pcs)
NBS-E 100/3L 100A 3P	100	004673041	3	36	(0,4-1) x ln x (0,9-1) / (1,5-10) x lr / 1500A	1,9	1
NBS-E 160/3L 160A 3P	160	004673055			(0,4-1) x ln x (0,9-1) / (1,5-10) x lr / 2400A	1,9	1
NBS-E 250/3L 250A 3P	250	004673079			(0,4-1) x ln x (0,9-1) / (1,5-10) x lr / 3000A	1,9	1
NBS-E 100/4L 100A 4P	100	004673042	4	36	(0,4-1) x ln x (0,9-1) / (1,5-10) x lr / 1500A	2,15	1
NBS-E 160/4L 160A 4P	160	004673056			(0,4-1) x ln x (0,9-1) / (1,5-10) x lr / 2400A	2,15	1
NBS-E 250/4L 250A 4P	250	004673080			(0,4-1) x ln x (0,9-1) / (1,5-10) x lr / 3000A	2,15	1

ETIBREAK NBS-E 400&630/3L...4L (L - 36kA)

Type	I <sub>N</sub> (A)	Code No.	Poles	I <sub>cs</sub> =I <sub>cu</sub> 415V(kA)	L (lr) / S (lsd) / I (li)	Weight (kg)	Packaging (pcs)
NBS-E 400/3L 400A 3P	400	004673109	3	36	(0,4-1) x ln x (0,9-1) / (1,5-10) x lr / 4800A	6,75	1
NBS-E 630/3L 630A 3P	630	004673139			(0,4-1) x ln x (0,9-1) / (1,5-10) x lr / 6930A	6,75	1
NBS-E 400/4L 400A 4P	400	004673110	4	36	(0,4-1) x ln x (0,9-1) / (1,5-10) x lr / 4800A	8,75	1
NBS-E 630/4L 630A 4P	630	004673140			(0,4-1) x ln x (0,9-1) / (1,5-10) x lr / 6930A	8,75	1



NBS-E 400/3L ..3S ..3H  
NBS-E 630/3L ..3S ..3H

ETIBREAK NBS-E 800...1600/3L...4L (L - 36kA)

Type	I <sub>N</sub> (A)	Code No.	Poles	I <sub>cs</sub> =I <sub>cu</sub> 415V(kA)	L (lr) / I (lsd)	Weight (kg)	Packaging (pcs)
NBS-E 1600/3L 800A 3P	800	004673160	3	36	(0,4-1) x ln / (1,5-10) x lr	13,8	1
NBS-E 1600/3L 1000A 3P	1000	004673161			(0,4-1) x ln / (1,5-10) x lr	13,8	1
NBS-E 1600/3L 1250A 3P	1250	004673162			(0,4-1) x ln / (1,5-10) x lr	13,8	1
NBS-E 1600/3L 1600A 3P	1600	004673163			(0,4-1) x ln / (1,5-10) x lr	13,8	1
NBS-E 1600/4L 800A 4P	800	004673165	4	36	(0,4-1) x ln / (1,5-10) x lr	17,5	1
NBS-E 1600/4L 1000A 4P	1000	004673166			(0,4-1) x ln / (1,5-10) x lr	17,5	1
NBS-E 1600/4L 1250A 4P	1250	004673167			(0,4-1) x ln / (1,5-10) x lr	17,5	1
NBS-E 1600/4L 1600A 4P	1600	004673168			(0,4-1) x ln / (1,5-10) x lr	17,5	1

ETIBREAK NBS-E (100..1600A, 50kA)

ETIBREAK NBS-E 100...250/3S...4S (S - 50kA)

Type	I <sub>N</sub> (A)	Code No.	Poles	I <sub>cs</sub> =I <sub>cu</sub> 415V(kA)	L (lr) / S (lsd) / I (li)	Weight (kg)	Packaging (pcs)
NBS-E 100/3S 100A 3P	100	004673043	3	50	(0,4-1) x ln x (0,9-1) / (1,5-10) x lr / 1500A	1,9	1
NBS-E 160/3S 160A 3P	160	004673057			(0,4-1) x ln x (0,9-1) / (1,5-10) x lr / 2400A	1,9	1
NBS-E 250/3S 250A 3P	250	004673081			(0,4-1) x ln x (0,9-1) / (1,5-10) x lr / 3000A	1,9	1
NBS-E 100/4S 100A 4P	100	004673044	4	50	(0,4-1) x ln x (0,9-1) / (1,5-10) x lr / 1500A	2,15	1
NBS-E 160/4S 160A 4P	160	004673058			(0,4-1) x ln x (0,9-1) / (1,5-10) x lr / 2400A	2,15	1
NBS-E 250/4S 250A 4P	250	004673082			(0,4-1) x ln x (0,9-1) / (1,5-10) x lr / 3000A	2,15	1



NBS-E 1600/3L ..3S ..3H

ETIBREAK NBS-E 400&630/3S...4S (S - 50kA)

Type	I <sub>N</sub> (A)	Code No.	Poles	I <sub>cs</sub> =I <sub>cu</sub> 415V(kA)	L (lr) / S (lsd) / I (li)	Weight (kg)	Packaging (pcs)
NBS-E 400/3S 400A 3P	400	004673111	3	50	(0,4-1) x ln x (0,9-1) / (1,5-10) x lr / 4800A	6,75	1
NBS-E 630/3S 630A 3P	630	004673141			(0,4-1) x ln x (0,9-1) / (1,5-10) x lr / 6930A	6,75	1
NBS-E 400/4S 400A 4P	400	004673112	4	50	(0,4-1) x ln x (0,9-1) / (1,5-10) x lr / 4800A	8,75	1
NBS-E 630/4S 630A 4P	630	004673142			(0,4-1) x ln x (0,9-1) / (1,5-10) x lr / 6930A	8,75	1

## Low voltage moulded case circuit breakers ETIBREAK NBS

**ETIBREAK NBS-E 800...1600/3S...4S (S - 50kA)**

Type	$I_N$ (A)	Code No.	Poles	$I_{cs}=I_{cu}$ 415V(kA)	L (lr) / I (lsd)	Weight (kg)	Packaging (pcs)
NBS-E 1600/3S 800A 3P	800	004673170	3	50	(0,4-1) x ln / (1,5-10) x lr	13,8	1
NBS-E 1600/3S 1000A 3P	1000	004673171			(0,4-1) x ln / (1,5-10) x lr	13,8	1
NBS-E 1600/3S 1250A 3P	1250	004673172			(0,4-1) x ln / (1,5-10) x lr	13,8	1
NBS-E 1600/3S 1600A 3P	1600	004673173			(0,4-1) x ln / (1,5-10) x lr	13,8	1
NBS-E 1600/4S 800A 4P	800	004673175	4	50	(0,4-1) x ln / (1,5-10) x lr	17,5	1
NBS-E 1600/4S 1000A 4P	1000	004673176			(0,4-1) x ln / (1,5-10) x lr	17,5	1
NBS-E 1600/4S 1250A 4P	1250	004673177			(0,4-1) x ln / (1,5-10) x lr	17,5	1
NBS-E 1600/4S 1600A 4P	1600	004673178			(0,4-1) x ln / (1,5-10) x lr	17,5	1

 NBS-E 100/4L ..4S ..4H  
 NBS-E 160/4L ..4S ..4H  
 NBS-E 250/4L ..4S ..4H

## ETIBREAK NBS-E (100..1600A, 65/85kA)

**ETIBREAK NBS-E 100...250/3H...4H (H - 85kA)**

Type	$I_N$ (A)	Code No.	Poles	$I_{cs}=I_{cu}$ 415V(kA)	L (lr) / S (lsd) / I (li)	Weight (kg)	Packaging (pcs)
NBS-E 100/3H 100A 3P	100	004673045	3	85	(0,4-1) x ln x (0,9-1) / (1,5-10) x lr / 1500A	1,9	1
NBS-E 160/3H 160A 3P	160	004673059			(0,4-1) x ln x (0,9-1) / (1,5-10) x lr / 2400A	1,9	1
NBS-E 250/3H 250A 3P	250	004673083			(0,4-1) x ln x (0,9-1) / (1,5-10) x lr / 3000A	1,9	1
NBS-E 100/4H 100A 4P	100	004673046	4	85	(0,4-1) x ln x (0,9-1) / (1,5-10) x lr / 1500A	2,15	1
NBS-E 160/4H 160A 4P	160	004673060			(0,4-1) x ln x (0,9-1) / (1,5-10) x lr / 2400A	2,15	1
NBS-E 250/4H 250A 4P	250	004673084			(0,4-1) x ln x (0,9-1) / (1,5-10) x lr / 3000A	2,15	1



NBS-E 400/4L ..4S ..4H

**ETIBREAK NBS-E 400&630/3H...4H (H - 85kA)**

Type	$I_N$ (A)	Code No.	Poles	$I_{cs}=I_{cu}$ 415V(kA)	L (lr) / S (lsd) / I (li)	Weight (kg)	Packaging (pcs)
NBS-E 400/3H 400A 3P	400	004673113	3	85	(0,4-1) x ln x (0,9-1) / (1,5-10) x lr / 4800A	6,75	1
NBS-E 630/3H 630A 3P	630	004673143			(0,4-1) x ln x (0,9-1) / (1,5-10) x lr / 6930A	6,75	1
NBS-E 400/4H 400A 4P	400	004673114	4	85	(0,4-1) x ln x (0,9-1) / (1,5-10) x lr / 4800A	8,75	1
NBS-E 630/4H 630A 4P	630	004673144			(0,4-1) x ln x (0,9-1) / (1,5-10) x lr / 6930A	8,75	1

**ETIBREAK NBS-E 800...1600/3H...4H (H - 65kA)**

Type	$I_N$ (A)	Code No.	Poles	$I_{cs}=I_{cu}$ 415V(kA)	L (lr) / I (lsd)	Weight (kg)	Packaging (pcs)
NBS-E 1600/3H 800A 3P	800	004673180	3	65	(0,4-1) x ln / (1,5-10) x lr	13,8	1
NBS-E 1600/3H 1000A 3P	1000	004673181			(0,4-1) x ln / (1,5-10) x lr	13,8	1
NBS-E 1600/3H 1250A 3P	1250	004673182			(0,4-1) x ln / (1,5-10) x lr	13,8	1
NBS-E 1600/3H 1600A 3P	1600	004673183			(0,4-1) x ln / (1,5-10) x lr	13,8	1
NBS-E 1600/4H 800A 4P	800	004673185	4	65	(0,4-1) x ln / (1,5-10) x lr	17,5	1
NBS-E 1600/4H 1000A 4P	1000	004673186			(0,4-1) x ln / (1,5-10) x lr	17,5	1
NBS-E 1600/4H 1250A 4P	1250	004673187			(0,4-1) x ln / (1,5-10) x lr	17,5	1
NBS-E 1600/4H 1600A 4P	1600	004673188			(0,4-1) x ln / (1,5-10) x lr	17,5	1



NBS-E 1600/4L ..4S ..4H

ETIBREAK NBS-E (L - 36kA, S - 50kA, with microprocessor release and LCD display)



NBS-E 100/3L ...3S LCD  
NBS-E 160/3L ...3S LCD  
NBS-E 250/3L ...3S LCD



NBS-E 400/3L ...3S LCD  
NBS-E 630/3L ...3S LCD

ETIBREAK NBS-E LCD (100..250A, 36kA)

**ETIBREAK NBS-E 100...250/3L...4L LCD (L - 36kA)**

Type	$I_N$ (A)	Code No.	Poles	$I_{cs}=I_{cu}$ 415V(kA)	L (lr) / S (lsd) / I (li)	Weight (kg)	Packaging (pcs)
NBS-E 100/3L LCD 100A 3P	100	004673047	3	36	(0,4-1) x ln / (1,5-12) x lr / (2-15) x ln	1,9	1
NBS-E 160/3L LCD 160A 3P	160	004673061				1,9	1
NBS-E 250/3L LCD 250A 3P	250	004673085				1,9	1
NBS-E 100/4L LCD 100A 4P	100	004673048	4	36	(0,4-1) x ln / (1,5-12) x lr / (2-15) x ln	2,15	1
NBS-E 160/4L LCD 160A 4P	160	004673062				2,15	1
NBS-E 250/4L LCD 250A 4P	250	004673086				2,15	1

ETIBREAK NBS-E LCD (400-630A, 36kA)

**ETIBREAK NBS-E 400&630/3L...4L LCD (L - 36kA)**

Type	$I_N$ (A)	Code No.	Poles	$I_{cs}=I_{cu}$ 415V(kA)	L (lr) / S (lsd) / I (li)	Weight (kg)	Packaging (pcs)
NBS-E 400/3L LCD 400A 3P	400	004673115	3	36	(0,4-1) x ln / (1,5-12) x lr / (2-15) x ln	6,75	1
NBS-E 630/3L LCD 630A 3P	630	004673145				6,75	1
NBS-E 400/4L LCD 400A 4P	400	004673116	4	36	(0,4-1) x ln / (1,5-12) x lr / (2-15) x ln	8,75	1
NBS-E 630/4L LCD 630A 4P	630	004673146				8,75	1

ETIBREAK NBS-E LCD (100..250A, 50kA)

**ETIBREAK NBS-E 100...250/3S...4S LCD (S - 50kA)**

Type	$I_N$ (A)	Code No.	Poles	$I_{cs}=I_{cu}$ 415V(kA)	L (lr) / S (lsd) / I (li)	Weight (kg)	Packaging (pcs)
NBS-E 100/3S LCD 100A 3P	100	004673049	3	50	(0,4-1) x ln / (1,5-12) x lr / (2-15) x ln	1,9	1
NBS-E 160/3S LCD 160A 3P	160	004673063				1,9	1
NBS-E 250/3S LCD 250A 3P	250	004673087				1,9	1
NBS-E 100/4S LCD 100A 4P	100	004673050	4	50	(0,4-1) x ln / (1,5-12) x lr / (2-15) x ln	2,15	1
NBS-E 160/4S LCD 160A 4P	160	004673064				2,15	1
NBS-E 250/4S LCD 250A 4P	250	004673088				2,15	1

ETIBREAK NBS-E LCD (400-630A, 50kA)

**ETIBREAK NBS-E 400&630/3S...4S LCD (S - 50kA)**

Type	$I_N$ (A)	Code No.	Poles	$I_{cs}=I_{cu}$ 415V(kA)	L (lr) / S (lsd) / I (li)	Weight (kg)	Packaging (pcs)
NBS-E 400/3S LCD 400A 3P	400	004673117	3	50	(0,4-1) x ln / (1,5-12) x lr / (2-15) x ln	6,75	1
NBS-E 630/3S LCD 630A 3P	630	004673147				6,75	1
NBS-E 400/4S LCD 400A 4P	400	004673118	4	50	(0,4-1) x ln / (1,5-12) x lr / (2-15) x ln	8,75	1
NBS-E 630/4S LCD 630A 4P	630	004673148				8,75	1

ETIBREAK NBS-E LCD (800-1600A, 36kA)

**ETIBREAK NBS-E 800&1600/3L...4L LCD (L - 36kA)**

Type	$I_N$ (A)	Code No.	Poles	$I_{cs}=I_{cu}$ 415V(kA)	L (lr) / S (lsd) / I (li)	Weight (kg)	Packaging (pcs)
NBS-E 1600/3L LCD 800A 3P	800	004673190	3	36	(0,4-1) x ln / (1,5-12) x lr / (2-15) x ln	13,8	1
NBS-E 1600/3L LCD 1000A 3P	1000	004673191				13,8	1
NBS-E 1600/3L LCD 1250A 3P	1250	004673192				13,8	1
NBS-E 1600/3L LCD 1600A 3P	1600	004673193				13,8	1
NBS-E 1600/4L LCD 800A 4P	800	004673195	4	36	(0,4-1) x ln / (1,5-12) x lr / (2-15) x ln	17,5	1
NBS-E 1600/4L LCD 1000A 4P	1000	004673196				17,5	1
NBS-E 1600/4L LCD 1250A 4P	1250	004673197				17,5	1
NBS-E 1600/4L LCD 1600A 4P	1600	004673198				17,5	1



## ETIBREAK NBS-E LCD (800-1600A, 50kA)

**ETIBREAK NBS-E 800&1600/3S...4S LCD (L - 50kA)**

Type	$I_N$ (A)	Code No.	Poles	$I_{cs=I_{cu}}$ 415V(kA)	L (lr) / S (lsd) / I (li)	Weight (kg)	Packaging (pcs)
NBS-E 1600/3S LCD 800A 3P	800	004673200	3	36	(0,4-1) x ln / (1,5-12) x lr / (2-15) x ln	13,8	1
NBS-E 1600/3S LCD 1000A 3P	1000	004673201				13,8	1
NBS-E 1600/3S LCD 1250A 3P	1250	004673202				13,8	1
NBS-E 1600/3S LCD 1600A 3P	1600	004673203	4	36	(0,4-1) x ln / (1,5-12) x lr / (2-15) x ln	13,8	1
NBS-E 1600/4S LCD 800A 4P	800	004673205				17,5	1
NBS-E 1600/4S LCD 1000A 4P	1000	004673206				17,5	1
NBS-E 1600/4S LCD 1250A 4P	1250	004673207				17,5	1
NBS-E 1600/4S LCD 1600A 4P	1600	004673208				17,5	1

## ETIBREAK NBS-EC (L - 36kA, S - 50kA, with microprocessor release, LCD display +RS485)

## ETIBREAK NBS-EC LCD (100..250A, 36kA) + RS485

**ETIBREAK NBS-EC 100&160&250/3L...4L LCD (L - 36kA)**

Type	$I_N$ (A)	Code No.	Poles	$I_{cs=I_{cu}}$ 415V(kA)	L (lr) / S (lsd) / I (li)	Weight (kg)	Packaging (pcs)
NBS-EC 100/3L LCD 100A 3P	100	004673051	3	36	(0,4-1) x ln / (1,5-12) x lr / (2-15) x ln	1,9	1
NBS-EC 160/3L LCD 160A 3P	160	004673065				1,9	1
NBS-EC 250/3L LCD 250A 3P	250	004673089				1,9	1
NBS-EC 100/4L LCD 100A 4P	100	004673052	4	36	(0,4-1) x ln / (1,5-12) x lr / (2-15) x ln	2,15	1
NBS-EC 160/4L LCD 160A 4P	160	004673066				2,15	1
NBS-EC 250/4L LCD 250A 4P	250	004673090				2,15	1

 NBS-EC 100/3L ...3S LCD  
 NBS-EC 160/3L ...3S LCD  
 NBS-EC 250/3L ...3S LCD

## ETIBREAK NBS-EC LCD (400-630A, 36kA) + RS485

**ETIBREAK NBS-EC 400&630/3L...4L LCD (L - 36kA)**

Type	$I_N$ (A)	Code No.	Poles	$I_{cs=I_{cu}}$ 415V(kA)	L (lr) / S (lsd) / I (li)	Weight (kg)	Packaging (pcs)
NBS-EC 400/3L LCD 400A 3P	400	004673119	3	36	(0,4-1) x ln / (1,5-12) x lr / (2-15) x ln	6,75	1
NBS-EC 630/3L LCD 630A 3P	630	004673149				6,75	1
NBS-EC 400/4L LCD 400A 4P	400	004673120	4	36	(0,4-1) x ln / (1,5-12) x lr / (2-15) x ln	8,75	1
NBS-EC 630/4L LCD 630A 4P	630	004673150				8,75	1

 NBS-EC 400/3L ...3S LCD  
 NBS-EC 630/3L ...3S LCD

## ETIBREAK NBS-EC LCD (100..250A, 50kA) + RS485

**ETIBREAK NBS-EC 100&160&250/3S...4S LCD (S - 50kA)**

Type	$I_N$ (A)	Code No.	Poles	$I_{cs=I_{cu}}$ 415V(kA)	L (lr) / S (lsd) / I (li)	Weight (kg)	Packaging (pcs)
NBS-EC 100/3S LCD 100A 3P	100	004673053	3	50	(0,4-1) x ln / (1,5-12) x lr / (2-15) x ln	1,9	1
NBS-EC 160/3S LCD 160A 3P	160	004673067				1,9	1
NBS-EC 250/3S LCD 250A 3P	250	004673091				1,9	1
NBS-EC 100/4S LCD 100A 4P	100	004673054	4	50	(0,4-1) x ln / (1,5-12) x lr / (2-15) x ln	2,15	1
NBS-EC 160/4S LCD 160A 4P	160	004673068				2,15	1
NBS-EC 250/4S LCD 250A 4P	250	004673092				2,15	1

## ETIBREAK NBS-EC LCD (400-630A, 50kA) + RS485

**ETIBREAK NBS-EC 400&630/3S...4S LCD (S - 50kA)**

Type	$I_N$ (A)	Code No.	Poles	$I_{cs=I_{cu}}$ 415V(kA)	L (lr) / S (lsd) / I (li)	Weight (kg)	Packaging (pcs)
NBS-EC 400/3S LCD 400A 3P	400	004673121	3	50	(0,4-1) x ln / (1,5-12) x lr / (2-15) x ln	6,75	1
NBS-EC 630/3S LCD 630A 3P	630	004673151				6,75	1
NBS-EC 400/4S LCD 400A 4P	400	004673122	4	50	(0,4-1) x ln / (1,5-12) x lr / (2-15) x ln	8,75	1
NBS-EC 630/4S LCD 630A 4P	630	004673152				8,75	1

Accessories

Internal accessories



Auxiliary switch 1xCO



Signal switch 1xCO



Shunt trip  
NBS-DA 100-630AF



Shunt trip  
NBS-DA 1600AF



Undervoltage trip  
NBS-NA 100-630AF

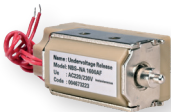

Undervoltage trip  
NBS-NA 1600AF



NBS-MO 100-250



NBS-MO 400-630



NBS-MO 1600

Auxiliary switch for NBS

Type	Code No.	Description	Compatibility	Packaging (pcs)
NBS-PS 100-1600AF	004673211	Auxiliary switch 1xCO	NBS 20-1600A	1/1

Operating current: 24V AC/DC – AC15/3A, DC14/1A; 220/240V AC – AC15/2A; 380/440V AC – AC15/1.5A.

Signal switch for NBS

Type	Code No.	Description	Compatibility	Packaging (pcs)
NBS-SS 100-1600AF	004673212	Signal switch 1xCO	NBS 20-1600A	1/1

Operating current: 24V AC/DC – AC15/3A, DC14/1A; 220/240V AC – AC15/2A; 380/440V AC – AC15/1.5A.

Shunt trip for NBS

Type	Code No.	Description	Compatibility	Packaging (pcs)
NBS-DA 100-630AF AC220/230V	004673215	Shunt trip AC 220-230V	NBS 20-630A	1/1
NBS-DA 100-630AF AC380/400V	004673216	Shunt trip AC 380-400V		1/1
NBS-DA 1600AF AC220/230V	004673217	Shunt trip AC 220-230V	NBS 800-1600A	1/1
NBS-DA 1600AF AC380/400V	004673218	Shunt trip AC 380-400V		1/1
NBS-DA 100-630AF DC24V	004673219	Shunt trip DC 24V	NBS 20-630A	1/1
NBS-DA 1600AF DC24V	004673220	Shunt trip DC 24V	NBS 800-1600A	1/1

IMPORTANT NOTE: The shunt trip unit NBS-DA and undervoltage trip unit NBS-NA cannot be mounted in the same breaker

Undervoltage trip for NBS

Type	Code No.	Description	Compatibility	Packaging (pcs)
NBS-NA 100-630AF AC220/230V	004673221	Undervoltage trip AC 220-230V	NBS 20-630A	1/1
NBS-NA 100-630AF AC380/400V	004673222	Undervoltage trip AC 380-400V		1/1
NBS-NA 1600AF AC220/230V	004673223	Undervoltage trip AC 220-230V	NBS 800-1600A	1/1
NBS-NA 1600AF AC380/400V	004673224	Undervoltage trip AC 380-400V		1/1

IMPORTANT NOTE: The shunt trip unit NBS-DA and undervoltage trip unit NBS-NA cannot be mounted in the same breaker

ETIBREAK NBS 100, 160, 250

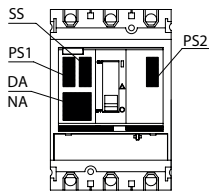

NBS-PS 100-1600AF  
NBS-SS 100-1600AF

ETIBREAK NBS 400, 630

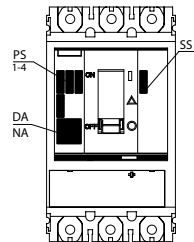

NBS-DA 100-630AF  
NBS-NA 100-630AF

ETIBREAK NBS 1600

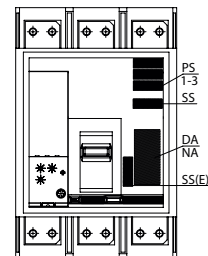

NBS-DA 1600AF  
NBS-NA 1600AF

External accessories

Motor operator for NBS

Type	Code No.	Description	Compatibility	Weight (kg)	Packaging (pcs)
NBS-MO 100-250AF AC220/230V	004673231	Motor operator AC 220-230V	NBS 20-250A	1,32	1
NBS-MO 400-630AF AC220/230V	004673232	Motor operator AC 220-230V	NBS 400-630A	3,67	1
NBS-MO 1600AF AC220/230V	004673233	Motor operator AC 220-230V	NBS 800-1600A	4,76	1
NBS-MO 100-250AF AC220/230V 4P	004673281	Motor operator AC 220-230V	NBS 20-250A	1,5	1
NBS-MO 400-630AF AC220/230V 4P	004673282	Motor operator AC 220-230V	NBS 400-630A	3,9	1
NBS-MO 1600AF AC220/230V 4P	004673283	Motor operator AC 220-230V	NBS 800-1600A	5,0	1

**Door mounted handle for NBS**

Type	Code No.	Description	Compatibility	Weight (kg)	Packaging (pcs)
NBS-RO 100-250AF	004673225	Door mounted handle	NBS 20-250A	0,45	1
NBS-RO 400-630AF	004673226	Door mounted handle	NBS 400-630A	0,65	1
NBS-RO 1600AF	004673227	Door mounted handle	NBS 800-1600A	2,12	1

NOTE: NBS-RO 100-250AF, NBS-RO 400-630AF - shaft length 470mm. NBS-RO 1600AF - shaft length 425mm.

**Plug-in kit for NBS**

Type	Code No.	Description	Compatibility	Weight (kg)	Packaging (pcs)
NBS-PLIN 100-250AF 3P	004673271*	Plug-in base	NBS 20-250A	1,25	1
NBS-PLIN 400-630AF 3P	004673272**	Plug-in base	NBS 400-630A	3,42	1
NBS-PLIN 100-250AF 4P	004673273*	Plug-in base	NBS 20-250A	1,6	1
NBS-PLIN 400-630AF 4P	004673274**	Plug-in base	NBS 400-630A	4,52	1

NOTE: \* Caution! The maximum rated current of the kit NBS-PLIN for NBS 100&250A circuit breakers without exceeding the permissible temperature is 210A. \*\* Caution! The maximum rated current of the kit NBS-PLIN for NBS 400&630A circuit breakers without exceeding the permissible temperature is 500A. NBS-PRS protective covers are included.

**Draw-out set for NBS**

Type	Code No.	Description	Compatibility	Weight (kg)	Packaging (pcs)
NBS-DOS 100-250AF 3P	004673275*	Chassis	NBS 20-250A	3,34	1
NBS-DOS 400-630AF 3P	004673276**	Chassis	NBS 400-630A	7,90	1
NBS-DOS 100-250AF 4P	004673277*	Chassis	NBS 20-250A	-	1
NBS-DOS 400-630AF 4P	004673278**	Chassis	NBS 400-630A	-	1

NOTE: \* Caution! The maximum rated current of the kit NBS-DOS for NBS 100&250A circuit breakers without exceeding the permissible temperature is 210A. \*\* Caution! The maximum rated current of the kit NBS-DOS for NBS 400&630A circuit breakers without exceeding the permissible temperature is 500A.

**Terminal protective cover for NBS**

Type	Code No.	Description	Compatibility	Weight (kg)	Packaging (pcs)
NBS-PRS 100-250AF 3P	004673235	Terminal cover	NBS 20-250A	0,08	2
NBS-PRS 400-630AF 3P	004673236	Terminal cover	NBS 400-630A	0,16	2
NBS-PRS 100-250AF 4P	004673237	Terminal cover	NBS 20-250A	0,11	2
NBS-PRS 400-630AF 4P	004673238	Terminal cover	NBS 400-630A	0,22	2

**Interpole barriers for NBS**

Type	Code No.	Description	Compatibility	Weight (kg)	Packaging (pcs)
NBS-IZ 100-250AF 3P	004673241	Interpole barriers	NBS 20-250A	0,10	4
NBS-IZ 400-630AF 3P	004673242	Interpole barriers	NBS 400-630A	0,15	4
NBS-IZ 1600AF 3P	004673243	Interpole barriers	NBS 800-1600A	0,20	4
NBS-IZ 100-250AF 4P	004673244	Interpole barriers	NBS 20-250A	0,15	6
NBS-IZ 400-630AF 4P	004673245	Interpole barriers	NBS 400-630A	0,23	6
NBS-IZ 1600AF 4P	004673246	Interpole barriers	NBS 800-1600A	0,30	6

**Attach busbars for NBS**

Type	Code No.	Description	Compatibility	Weight (kg)	Packaging (pcs)
NBS-ZB 100-250AF 3P	004673251	Interpole barriers	NBS 20-250A	0,28	6
NBS-ZB 400-630AF 3P	004673252	Interpole barriers	NBS 400-630A	0,75	6
NBS-ZB 1600AF 3P	004673253	Interpole barriers	NBS 800-1600A	3,15	6
NBS-ZB 100-250AF 4P	004673254	Interpole barriers	NBS 20-250A	0,38	8
NBS-ZB 400-630AF 4P	004673255	Interpole barriers	NBS 400-630A	1,01	8
NBS-ZB 1600AF 4P	004673256	Interpole barriers	NBS 800-1600A	4,29	8

**Cable clamp terminals for NBS**

Type	Code No.	Description	Compatibility	Weight (kg)	Packag. (pcs)
NBS-TC 100-250AF 3P / 4P	004673261/62	Clamps for flexible conductors 150-240mm <sup>2</sup>	NBS 20-250A	0,12 / 0,27	6/8



NBS-RO 100-250 NBS-RO 400-630  
NBS-RO 1600  
NBS-PLIN 100-250A NBS-PLIN 400-630A

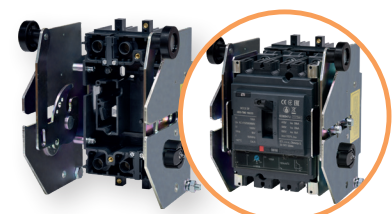

NBS-DOS 100-250A



NBS-PRS 400-630A



NBS-IZ



NBS-ZB

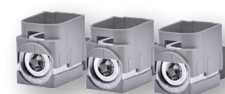

NBS-TC

Release types

20-160A NBS-TMS

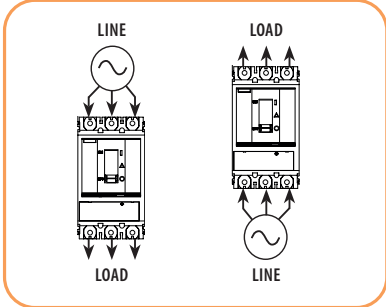
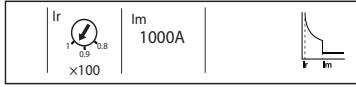

Thermomagnetic release NBS-TMS

MCCB's with thermomagnetic release can be used in industrial and commercial electrical installations for protection of cables supplied by transformers.

**Protection:**

**Thermal protection (Ir)**

Overload protection (thermal protection) is ensured by using a bimetallic plate which will be activated when its temperature, due to overcurrent, will increase and consequently activate the switching mechanism which will trip the MCCB.

Overload protection setting Ir - adjustable in amperes (A) within 0.8 - 1 of rated current of the MCCB.

**Magnetic protection (Im)**

Protection against short circuits is carried out using an electromagnetic release, which performs an instant shutdown of the MCCB, when the Im set point is exceeded. In this series of MCCB's Im is fixed and it is 10 x In.

**Note:** Adjustment dials are covered with transparent covers which can be sealed.

**Thermomagnetic release NBS-TMS**

Rated current (A)	In at 40°C	20	25	32	40	50	63	80	100	125	160
MCCB type	NBS-TMS 100	•	•	•	•	•	•	•	•		
	NBS-TMS 160									•	•
<b>Thermal protection</b>											
Current setting (A) Release between 1.05 and 1.2 Ir	Ir = In x ...	Adjustable in range from 0.8 to 1 x In									
Time adjustment (s)	tr	NON - adjustable									
<b>Electromagnetic protection</b>											
Current setting (A) Tolerance ±20%	Im	NON - adjustable Im = 10 x In									

200-600A NBS-TMD

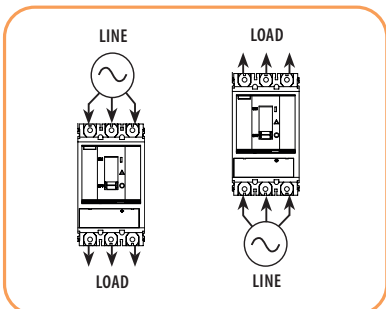
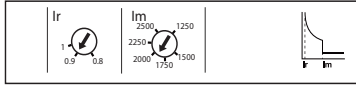

Thermomagnetic release NBS-TMD

MCCB's with thermomagnetic release can be used in industrial and commercial electrical installations for protection of cables supplied by transformers.

**Protection:**

**Thermal protection (Ir)**

Overload protection (thermal protection) is ensured by using a bimetallic plate which will be activated when its temperature, due to overcurrent, will increase and consequently activate the switching mechanism which will trip the MCCB.

Overload protection setting Ir - adjustable in amperes for ratings 200-250A within 0.8 - 1, and for ratings 315-600A within 0.7 - 1 of the rated current of MCCB.

**Magnetic protection (Im)**

Protection against short circuits is carried out using an electromagnetic release, which performs an instant shutdown of the MCCB, when the Im set point is exceeded. In this series of MCCB's Im is adjustable between 5 and 10 x In.

**Note:** Adjustment dials are covered with transparent covers which can be sealed.

**Thermomagnetic release NBS-TMD**

Rated current (A)	In at 40°C	200	250	315	400	500	600
MCCB type	NBS-TMD 250	•	•				
	NBS-TMD 400			•	•		
	NBS-TMD 630					•	•
<b>Thermal protection</b>							
Current setting (A) Release between 1.05 and 1.2 Ir	Ir = In x ...	Adjustable in range from 0.8 to 1 x In			Adjustable in range from 0.7 to 1 x In		
Time adjustment (s)	tr	NON - adjustable					
<b>Electromagnetic protection</b>							
Current setting (A) Tolerance ±20%	Im	Adjustable Im = (5-10) x In					

## Electronic release NBS-E (100-630A)

MCCB's with electronic release can be used in industrial and commercial electrical installations for protection of cables supplied by transformers.

**Protection:**

Adjustment dials on the front panel provides fine adjustment.

**L Overload protection (Ir)**

Inverse time protection against overloads with 2 adjustment dials:

lo- rough adjustment between 0,4 to 1 x In

lr - fine adjustment between 0,9 and 1 of set lo

**S Fixed time delayed short-circuit protection (I<sub>sd</sub>)**

Protection with an adjustable pick-up I<sub>sd</sub>. Tripping takes place after a very short delay used to allow discrimination with the downstream device.

**I Instantaneous short-circuit protection (I<sub>i</sub>)**

Instantaneous short-circuit protection with non-adjustable current setting I<sub>i</sub>.

**Indication:**

On the front panel of the MCCB are 3 LED lights indicating the status of the breaker:

**Green** - ready LED. Flashes slowly, signaling that MCCB is working and is prepared to operate, protect the installation. Minimum load current is required so that this function will work... minimum load current of 30A for MCCB with rated current up to 250A and 50A for MCCB with a rated current of more than 250A.

**Orange** - overload warning LED. Lights up when current is higher than 90% of the set value of I<sub>r</sub>.

**Red** - overload alarm LED. Lights up when the current is higher than 105% of the set value of I<sub>r</sub>.

**Note:** Adjustment dials are covered with transparent covers which can be sealed.

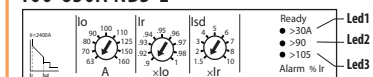
**100-630A NBS-E**

**Indication**

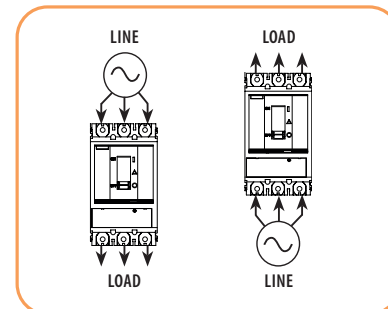
- Led1 - green
- Led2 - orange
- Led3 - red

**Electronic release NBS-E**

Rated current (A)	In at 40°C	100	160	250	400	630
MCCB type	NBS-E 100	•				
	NBS-E 160		•			
	NBS-E 250			•		
	NBS-E 400				•	
	NBS-E 630					•

**(L) Overload protection**

Current setting (A) Switching off between 1,05 and 1,2 I <sub>r</sub>	I <sub>o</sub>	Value of possible current settings depending on I <sub>n</sub> adjustment dials positions									
		I <sub>n</sub> = 100	I <sub>o</sub> =	40	45	50	55	63	70	80	90
I <sub>n</sub> = 160	I <sub>o</sub> =	63	70	80	90	100	110	125	150	160	
I <sub>n</sub> = 250	I <sub>o</sub> =	100	112	125	140	160	175	200	225	250	
I <sub>n</sub> = 400	I <sub>o</sub> =	160	180	200	230	250	280	320	360	400	
I <sub>n</sub> = 630	I <sub>o</sub> =	250	280	320	350	400	450	500	570	630	
I <sub>r</sub> = I <sub>o</sub> x ...		Fine adjustment from 0.9 to 1, possible positions (0.9 – 0.92 – 0.93 – 0.94 – 0.95 – 0.96 – 0.97 – 0.98 – 1) for each value of I <sub>o</sub>									
Time adjustment (s)	t <sub>r</sub>	NON - adjustable									

**Selective current disconnection with constant time setting**

Current setting(A) Tolerance ±10%	I <sub>sd</sub> = I <sub>r</sub> x ...	1,5	2	3	4	5	6	7	8	10	
Time delay (ms)	t <sub>sd</sub>	NON - adjustable									
	min tripping time	20									
	max tripping time	80									

**Instantaneous protection**

Current setting (A) Tolerance ±15 %	NON - adjustable I <sub>i</sub>	1500	2400	3000	4800	6930
min tripping time		10ms				
	max tripping time	50ms				



800-1600A NBS-E

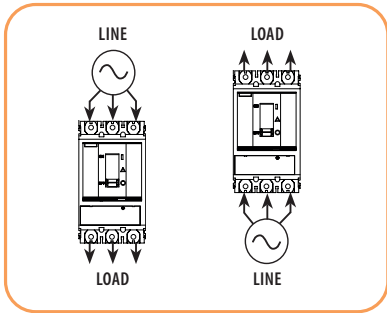
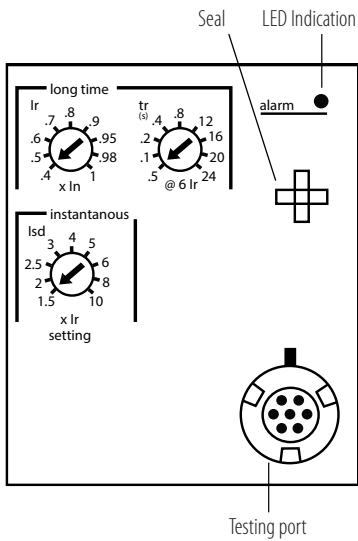

Electronic release NBS-E (800-1600A)

MCCB's with electronic release can be used in industrial and commercial electrical installations for protection of cables supplied by transformers.

**Protection:**

Protection settings are made by using adjustment dials on the front panel of the MCCB.

**(L) Overload protection (Ir)**

Inverse time protection against overloads with 2 adjustment dials:

Ir - setting of release current in amperes between 0,4 to 1 x In

tr - overload time protection setting

**(I) Instantaneous short-circuit protection (Isd)**

Protection with an adjustable pick-up Isd. Tripping takes place after a very short delay used to allow discrimination with the downstream device.

**Indication:**

On the front panel of the MCCB is an overload LED alarm which lights up when the load exceeds the set value of Ir.

Electronic release NBS-E					
Rated current(A)	In at 40°C	800	1000	1250	1600
MCCB type	NBS-E 800	•			
	NBS-E 1000		•		
	NBS-E 1250			•	
	NBS-E 1600				•

(L) Overload protection													
Current setting (A) Switching off between 1,05 and 1,2 Ir	In = 800	Ir =	Value of possible current settings depending on In adjustment dials positions										
			In = 1000	In = 1250	In = 1600	Ir =	320	400	480	560	640	720	760
				400	500	600	700	800	900	950	980	1000	
				500	625	750	875	1000	1125	1187	1225	1250	
				640	800	960	1120	1280	1440	1520	1568	1600	
Time setting (s)	Load current		Adjusted value										
			0,5	1	2	4	8	12	16	20	24		
	1,5 x Ir (tolerance 0-30%)		12,5	25	50	100	200	300	400	500	600		
	6 x Ir (tolerance 0-20%)		0,5	1	2	4	8	12	16	20	24		
	7,2 x Ir (tolerance 0-20%)		0,7	0,69	1,38	2,7	5,5	8,3	11	13,8	16,6		

(I) Instantaneous protection										
Current setting (A) Tolerance ±10%	Isd = Ir x ...	1,5	2	2,5	3	4	5	6	8	10
		min tripping time	20 ms							
	max tripping time	80 ms								

Electronic release NBS-E LCD

NBS-E LCD MCCB's have a built-in display to indicate parameter settings and display of measurement values and are equipped with a microprocessor-based trip unit, which has significant advantages compared to a thermomagnetic release: a diverse selection of settings needed by the user, high accuracy of execution of the given program, status indicators of release.

This makes it possible to use these switches in various areas, in particular during construction of selective protection schemes

**Protection:**

Protection settings are made using the control buttons on the front panel of the MCCB with the possibility of fine adjustment. The setting buttons are covered with transparent covers which can be sealed.

**L Overload protection (Ir)**

Inverse time protection against overloads with 2 adjustments:

Ir- setting of release current in amperes

tr - overload time protection setting

**S Time delay short-circuit protection (I<sub>sd</sub>)**

Selective current tripping with adjustable current setting I<sub>sd</sub> and adjustable time setting t<sub>sd</sub>.

**I Instantaneous short-circuit protection (I<sub>i</sub>)**

Instantaneous short-circuit protection with adjustable current setting I<sub>i</sub>.

**Indication:**

**Green** - ready LED. Flashes slowly, signaling that MCCB is working and is prepared to operate, protect the installation. Minimum load current is required so that this function will work.... minimum load current of 30A for MCCB with rated current up to 250A and 50A for MCCB with a rated current of more than 250A.

**Orange** - overload warning LED. Lights up when current is higher than 90% of the set value of I<sub>r</sub>.

**Red** - overload alarm LED. Lights up when the current is higher than 105% of the set value of I<sub>r</sub>.

NBS-E LCD MCCB's do not have a built-in microprocessor power source, therefore, for setting the necessary settings, through the circuit breaker should flow minimum load current. For MCCB's with rated current up to 250A the minimum load current must be greater than 40A and for MCCB's with rated current from 400A, the minimum load current must be higher than 50A.

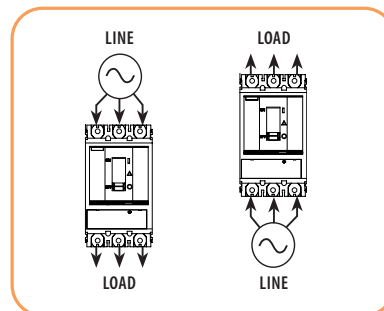
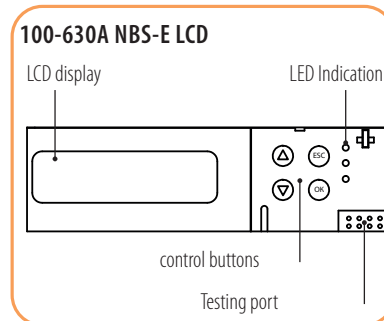

**Electronic release NBS-E LCD**

Rated current(A)	I <sub>n</sub> at 40°C	100	160	250	400	630
MCCB type	NBS-E 100 LCD	•				
	NBS-E 160 LCD		•			
	NBS-E 250 LCD			•		
	NBS-E 400 LCD				•	
	NBS-E 630 LCD					•

**(L) Overload protection**

Current setting (A) Switching off between 1,05 and 1,2 I <sub>r</sub>	I <sub>r</sub> = ...	Settings by using control buttons	The exact setting of the overload protection is carried out by using buttons with a step of 1A in the range between 0.4 and 1 x I <sub>n</sub>					
Time adjustment (s) Tolerance 0-20%	tr = ...	Settings by using control buttons	The setting is carried out using control buttons in steps by 0.1 s. / OFF - overload protection is disabled.					
Time setting (s) Tolerance 0-20%	Load current		Setting value					
			1,5	2	4	8	12	
			1,5 x I <sub>r</sub>	33	50	100	200	300
			6 x I <sub>r</sub>	1,5	2	4	8	12
	7,2 x I <sub>r</sub>	1	1,4	2,8	5,5	8,2		

**(S) Fixed time delay short circuit protection**

Current setting (A) Tolerance ±10%	I <sub>sd</sub> = I <sub>r</sub> x ...	The exact setting of the short-circuit protection is carried out by using control buttons in steps of 0.5 x I <sub>n</sub> in the range between 1.5 and 12 x I <sub>n</sub>				
Time setting (s)	t <sub>sd</sub> = ...	Settings using the control buttons / OFF - protection against short circuits is disabled.				
		Settings value				
		0,00	0,10	0,20	0,30	0,40
		min tripping time (ms)	20	80	140	230
	max tripping time (ms)	80	140	200	320	500

**(I) Instantaneous short circuit protection**

Current setting (A) Tolerance ±15%	I <sub>i</sub> = ...	Adjustment is carried out using the control buttons with a step of 1 x I <sub>n</sub> in the range from 2 to 15 x I <sub>n</sub> / OFF - instantaneous protection is disabled				
	min tripping time	10 ms				
	max tripping time	50 ms				

100-630A NBS-EC LCD

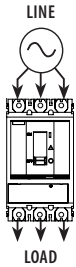
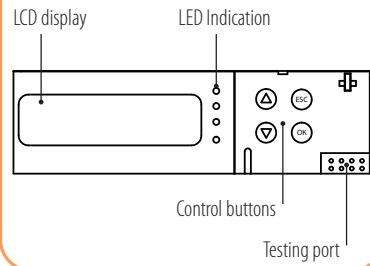

**WARNING!** Connection scheme:  
Power supply - from the top,  
Load - from the bottom.



Electronic release NBS-EC LCD

NBS-EC LCD MCCB's have a built-in display to indicate parameter settings and display of measurement values and are equipped with a microprocessor-based trip unit, which has significant advantages compared to a thermomagnetic release: a diverse selection of settings needed by the user, high accuracy of execution of the given program, status indicators of release. This makes it possible to use these switches in various areas, in particular during construction of selective protection schemes.

**Protection:**

Protection settings are made using the control buttons on the front panel of the MCCB with the possibility of fine adjustment. The setting buttons are covered with transparent covers which can be sealed.

**L Overload protection (I<sub>r</sub>)**

Inverse time protection against overloads with 2 adjustments:

- I<sub>r</sub> - setting of release current in amperes
- t<sub>r</sub> - overload time protection setting

**S Time delay short-circuit protection (I<sub>sd</sub>)**

Selective current tripping with adjustable current setting I<sub>sd</sub> and adjustable time setting t<sub>sd</sub>.

**I Instantaneous short-circuit protection (I<sub>i</sub>)**

Instantaneous short-circuit protection with adjustable current setting I<sub>i</sub>.

**Indication:**

On the front panel of the MCCB are 3 LED lights indicating the status of the breaker:

- Green** - ready LED. Flashes slowly, signaling that MCCB is working and is prepared to operate, protect the installation. Minimum load current is required so that this function will work.... minimum load current of 30A for MCCB with rated current up to 250A and 50A for MCCB with a rated current of more than 250A.
- Orange** - overload warning LED. Lights up when current is higher than 90% of the set value of I<sub>r</sub>.
- Red** - overload alarm LED. Lights up when the current is higher than 105% of the set value of I<sub>r</sub>.

NBS-EC LCD MCCB's have a built-in RS 485 communication port and a power source microprocessor. When connecting the supply voltage to any of two upper terminals of the switch, the microprocessor is activated, making it possible to configure it. In addition to basic protections NBS-EC LCD switches have a number of additional protections and functions. When installing these MCCB's, it is important to follow the connection diagram: power supply - from the top, load - from the bottom.

Electronic release NBS EC LCD

Rated current(A)	In at 40°C	100	160	250	400	630
Electronic release	NBS-EC 100 LCD	•				
	NBS-EC 160 LCD		•			
	NBS-EC 250 LCD			•		
	NBS-EC 400 LCD				•	
	NBS-EC 630 LCD					•

**(L) Overload protection**

Current setting (A) Switching off between 1.05 and 1.2 I <sub>r</sub>	I <sub>r</sub> = ...	Settings by using control buttons	The exact setting of the overload protection is carried out by using buttons with a step of 1A in the range between 0.4 and 1 x I <sub>n</sub>						
Time adjustment (s) Tolerance 0-20%	t <sub>r</sub> = ...	Settings by using control buttons	The setting is carried out using control buttons in steps by 1 s						
Time setting (s) Tolerance 0-20%	Load current	Setting value							
		0,5	1	2	4	8	16	24	
		1,5 x I <sub>r</sub>	15	25	50	100	200	400	600
		6 x I <sub>r</sub>	0,5	1	2	4	8	16	24
	7,2 x I <sub>r</sub>	0,35	0,7	1,4	2,8	5,5	11	16	

**(S) Fixed time delay short circuit protection**

Current setting (A) Tolerance ±10%	I <sub>sd</sub> = I <sub>r</sub> x ...	The exact setting of the short-circuit protection is carried out by using control buttons in steps of 0.5 x I <sub>n</sub> in the range between 1.5 and 12 x I <sub>n</sub>					
Time setting (s)	t <sub>sd</sub> = ...	Settings using the control buttons					
		Setting value					
		0,00	0,10	0,20	0,30	0,40	
		min tripping time (ms)	20	80	140	230	350
	max tripping time (ms)	80	140	200	320	500	

**(I) Instantaneous short circuit protection**

Current setting (A) Tolerance ±15%	I <sub>i</sub> = ...	Adjustment using buttons in steps of 1A in the range from 2 to 15x I <sub>n</sub>					
	min tripping time	10ms					
	max tripping time	50ms					



## Electronic release NBS-EC LCD

**Additional protection and features**

Over-voltage protection	$U_{max}$	Voltage range adjustment	140-520 V (Phase)	Trip - Switching OFF Alarm - Signalisation OFF - Protection is disabled
		Tripping time adjustment	36-1 s	
Under-voltage protection	$U_{min}$	Voltage range adjustment	100-500 V (Phase)	
		Tripping time adjustment	36-1 s	
Phase loss protection	Open-phase	Voltage range adjustment	50-80 V (Phase)	
		Tripping time adjustment	0,2-5 s	
Phase sequence protection	Phase rotation	Choice of configurations	ABC; ACB	
		Fixed trigger time	0,3s	
Over-frequency protection	$F_{max}$	Frequency adjustment range	45-65 Hz	
		Tripping time adjustment	0,2-5 s	
Under-frequency protection	$F_{min}$	Frequency adjustment range	45-65 Hz	
		Tripping time adjustment	0,2-5 s	
Phase asymmetry protection	$U_{unbal}$	Asymmetry adjustment range	5-30 %	
		Tripping time adjustment	1-40 s	
Over temperature protection	Overtemper.	Temperature control range	40-80 °C	
		Tripping time adjustment	1-60 s	
Measurement	I	Current in each phase, current unbalance ratio		
	U	Phase and line voltage, voltage imbalance factor		
	F	Frequency		
Event registration log	Trip history	Registration of trippings due to various types of protection		
	Alarm history	Registration of warnings		
	CO history	Registration of ON and OFF functions		
Additionally	RTC	Built-in real-time clock		
	Temperature	Built-in temperature sensor		
	Contact wear	Contact wear monitoring		
	User password	Ability to set a password to protect against unauthorized access		



All protection functions have 3 modes of operation:

**Trip** - the protective function is enabled. If the control values are exceeded, the MCCB is turned off;

**Alarm** - LED alarm is on. When the control values are exceeded, red LED starts to flash;

**OFF** - protection functions and indications are disabled.



**Electrical control using motorised operation**

**Application** - Motor operators provide the possibility of opening and closing an MCCB on application of electrical control signals.

**Ratings and specifications**

MCCB Frame size		100, 160, 250	400, 630	1600
Rated operating voltage		220-230V AC		
Rated frequency		50-60Hz		
Power loss	Rated working power (W)	2W	2W	2W
	Peak value (W)	25W	50W	65W
Required power supply (W)		>100W	>200W	>200W
Starting current (A)		≤0,25A	≤0,45A	≤0,50A
Rated parameters	Voltage (V)	AC230V	AC230V	AC230V
	Voltage (A)	Only voltage is required for starting, no current		
Operating method		Direct drive		
Tripping time		0,7-1,5 sec.		
Dielectric properties		1500V < 5 sec.		
Operating temperature range		-5 ~ +40°C		
Climatic conditions		50°C, humidity 90%		
Weight (kg)		1,28	3,58	4,00

Motor operator connection diagram

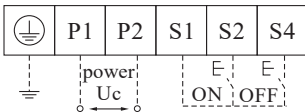

The NBS-MO is a special device driven by a small DC motor, the purpose of which is remote control of MCCB's with rated currents from 20 to 1600A.

- To install the Motor operator on the NBS 100, 160 & 250 it is necessary to remove the extension handle. For installing the Motor operator on the NBS 400, 630 & 1600, it is necessary to replace the extension handle on the MCCB with the one that comes together with Motor operator.

- The motor drive allows 10 operations (ON/OFF) in a row with at least 10s pause between operations.  
 - In the presence of voltage in the control circuit of the Motor operator, the process of switching ON and OFF ends automatically if the contacts of the electric drive control buttons were in the closed position for at least 0.2 seconds.

- After installing the Motor operator, you should first carry out a trial operation manually so that you check whether it is possible to turn ON and OFF the MCCB and switch it to the "TRIP" position.

- When connecting a Motor operator without an installed MCCB and supplying connections on terminals, continuous rotation of the drive mechanism without stops is considered as a normal mode of operation.

**IMPORTANT!** After the automatic activation of the device, it is necessary to eliminate the cause of tripping, inspect the device and only then turn the toggle to the "OFF" position. Turning ON can be performed after identifying and eliminating the causes of the tripping.

**IMPORTANT!** For manual control, rotate the handle 180 degrees clockwise, counterclockwise rotation is prohibited.

If the angle of rotation was less than 180 degrees, turning ON the MCCB, using the control terminals, will not be possible. To do this, it is necessary to set the handle to the correct angle manually or send a command to the "OFF" terminal.

If the angle of rotation was less than 180 degrees when opening the power contacts of the MCCB, using the manual control handle, then when the mode switch is turned to the "AUTO" position, the Motor operator will automatically move the mechanism, after which the ON command can be given.

Dimensions of Motor operator

NBS-MO 100-250AF

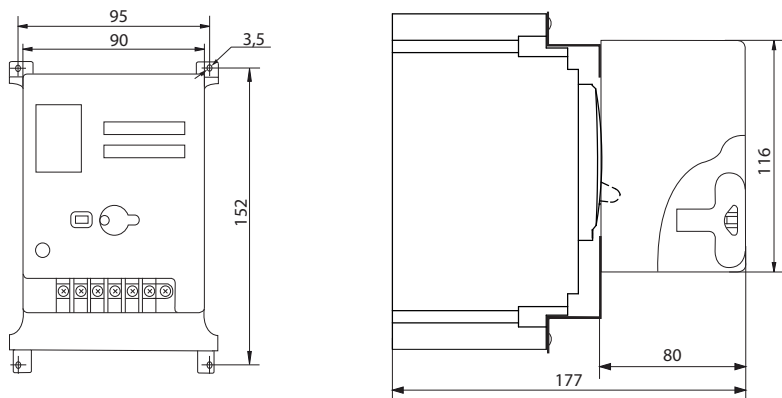

NBS-MO 400-630AF

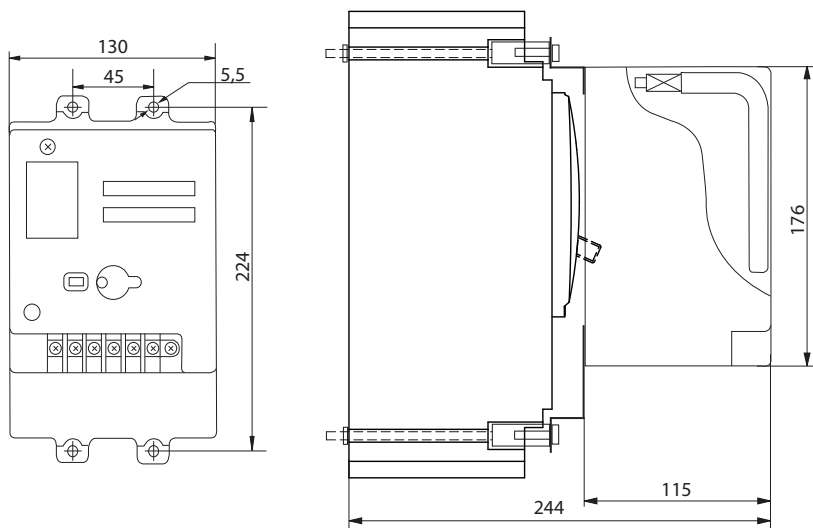

NBS-MO 1600AF

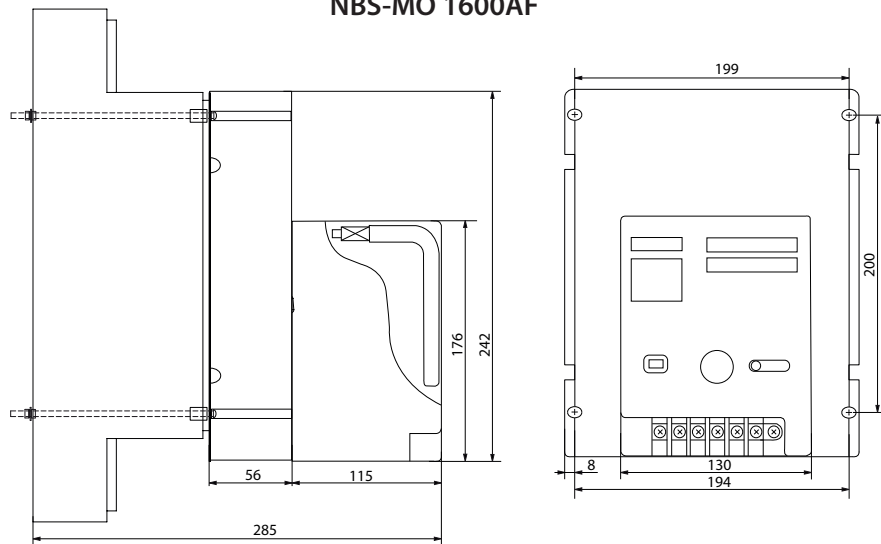

Technical data

Technical characteristics																											
				NBS 100				NBS 160				NBS 250				NBS 400				NBS 630				NBS 1600			
Parameters/Electrical characteristics																											
Release type				TMS	E	E LCD	EC LCD	TMS	E	E LCD	EC LCD	TMD	E	E LCD	EC LCD	TMD	E	E LCD	EC LCD	TMD	E	E LCD	EC LCD	E			
Nr. Poles				3 / 4				3 / 4				3 / 4				3 / 4				3 / 4				3 / 4			
Nominal current	In	(A)	40 °C	20, 25, 32, 40, 50, 63, 80, 100	100	100	100	125, 160	160	160	160	200, 250	250	250	250	315, 400	400	400	400	500, 600	630	630	630	800, 1000, 1250, 1600			
Model-type				L	S	L	S	H	L	S	L	S	L	S	H	L	S	L	S	L	S	L	S	L	S	H	
Service breaking capacity Ics = 100% Icu	Ics	(kA)	415 V	36	50	36	50	85	36	50	36	50	36	50	36	50	36	50	36	50	36	50	36	50	65		
				500 V	25	35	25	35	50	25	35	25	35	25	35	25	35	25	35	25	35	25	35	25	35	45	
				690 V	6				6				6				8	10	8	10	8	10	8	10	8	10	20
Rated operational voltage	Ue	(V)	AC 50/60 Hz	690				690				690				690				690							
				DC	250	-				250	-				250	-				250	-						
Rated insulation voltage	Ui	(V)		1000				1000				1000				1000				1000							
Rated impulse withstand voltage	Uimp	(kV)		8				8				8				8				8							
Protection																											
Adjustable thermal / fixed magnetic				□	-	-	-	□	-	-	-	-	-	-	-	-	-	-	-	-	-	-	-	-			
Adjustable thermal / adjustable magnetic				-	-	-	-	-	-	-	-	□	-	-	-	□	-	-	-	□	-	-	-	-			
Microprocessor				-	□	□	□	-	□	□	□	-	□	□	□	-	□	□	□	-	□	□	□	□			
Utilisation category				A				A				A				A				A				B			
Installation																											
Front connection				□				□				□				□				□							
Attached flat bar				●				●				●				●				●							
Cable clamp terminals				●				●				●				-				-							
Plug-in				●				●				●				●				●							
Draw-out				●				●				●				●				●							
Dimensions 3P / 4P	h	(mm)		161				161				161				255				255				326			
	w	(mm)		105 / 140				105 / 140				105 / 140				140 / 185				140 / 185				210 / 280			
	d	(mm)		86				86				86				111				111				147			
Weight 3P / 4P	W	(kg)		1,9 / 2,15				1,9 / 2,15				1,9 / 2,15				6,75 / 8,75				6,75 / 8,75				13,8 / 17,5			
Operation																											
Direct opening action				□				□				□				□				□							
Door mounted handle				●				●				●				●				●							
Motor operator				●				●				●				●				●							
Endurance	Electrical			10000				8000				8000				6000				5000				1500			
	Mechanical			20000				20000				20000				10000				10000				10000			

- - Standard
- - Optional
- - Not available

External accessories

NBS 100, 160, 250, 400, 630

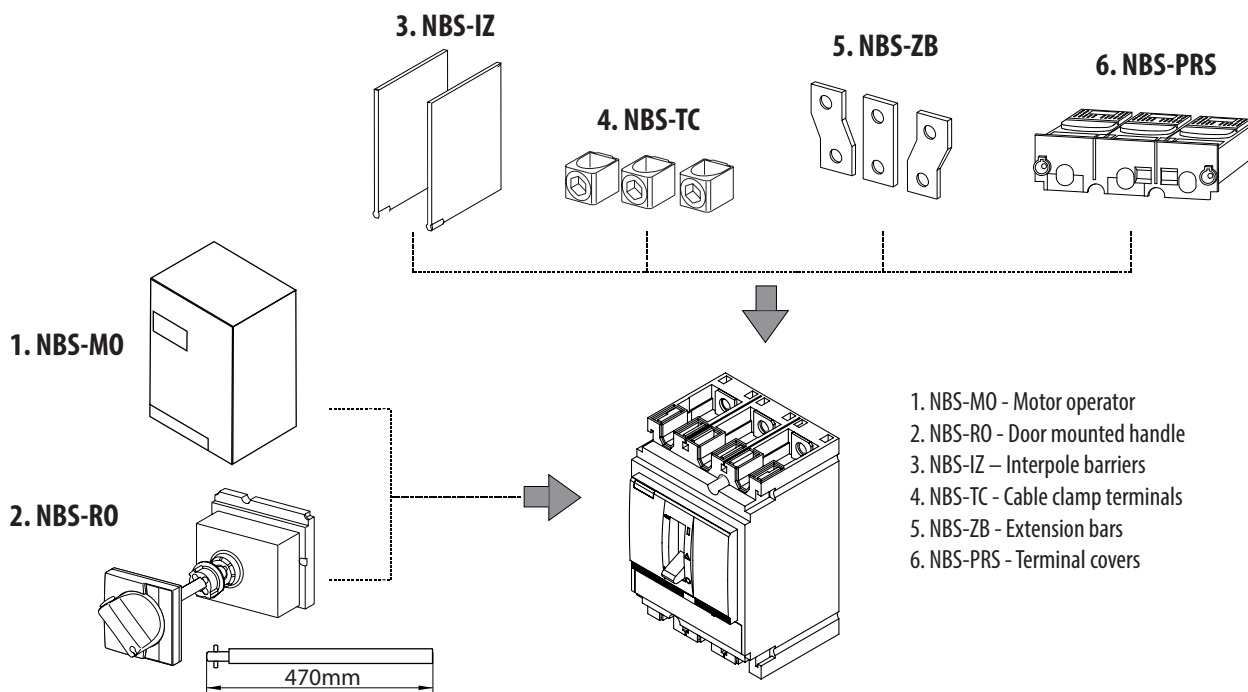

NBS 1600

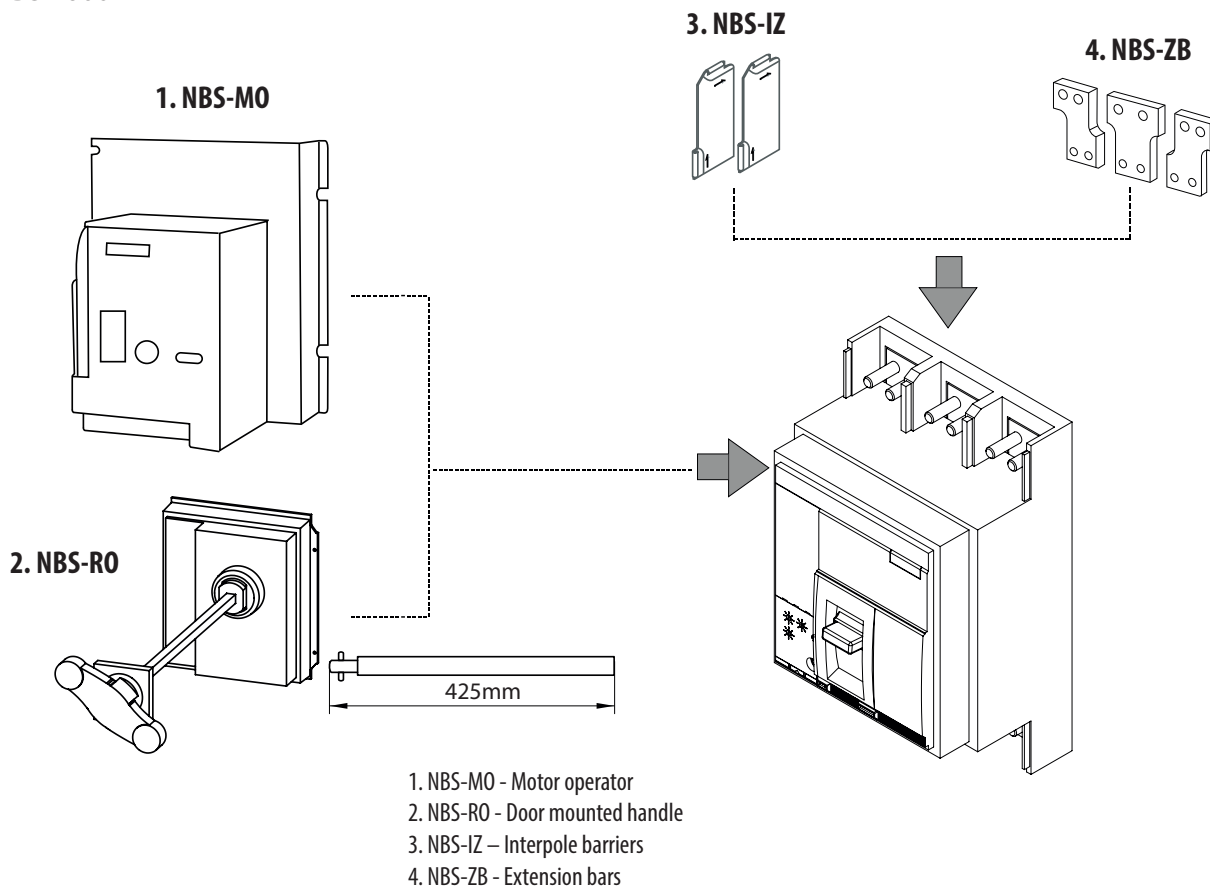

Parameters and dimensions of the elements to be connected

Dimensions of connection accessories

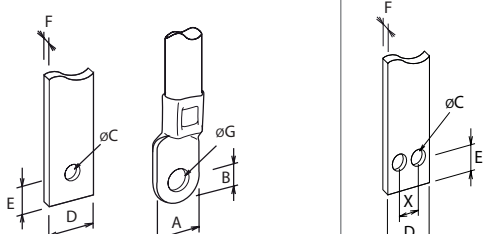

	NBS 100 (mm)	NBS 160/250 (mm)	NBS 400/630 (mm)	NBS 1600 (mm)
A	≤25	≤25	≤32	-
B	≤10	≤10	≤15	-
C	≥6	≥8	≥10	≥11
D	≤25	≤25	≤32	≤45
E	≤10	≤10	≤15	≤10,5
F	≤6	≤6	≤10	≤10
G	≥6	≥8	≥10	-
X	-	-	-	25

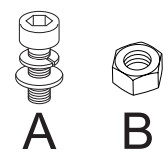
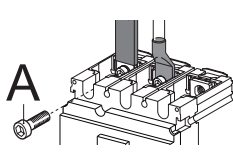
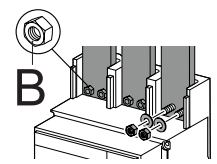
Connecting type element		Front connection NBS 100, 160, 250, 400, 630	Front connection NBS 1600
			
Frame size	Rated current	In complete with MCCB	In complete with MCCB
NBS 100	20-100	M6x20 (A) / 3 (Nm)	-
NBS 160/250	125-250	M8x20 (A) / 6 (Nm)	-
NBS 400/630	400-630	M10x27,5 (A) / 10 (Nm)	-
NBS 1600	800-1600	-	M10 (B) / 10 (Nm)

Cable clamp terminals

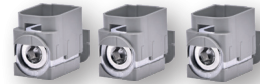

NBS-TC 100-250AF 3P

S=120-185 mm<sup>2</sup>  
(1 conductor) Cu/Al

Extension bars NBS-ZB

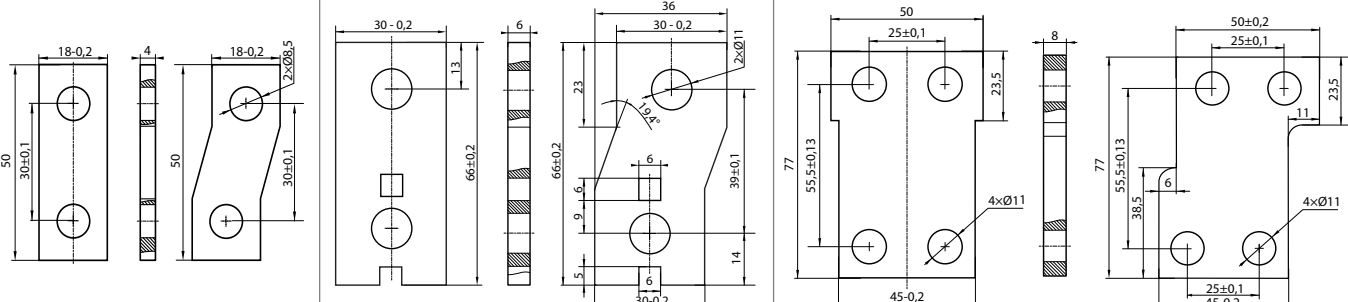

NBS-ZB 100-250AF 3P	NBS-ZB 400-630AF 3P	NBS-ZB 1600AF 3P
---------------------	---------------------	------------------

Mounting angle

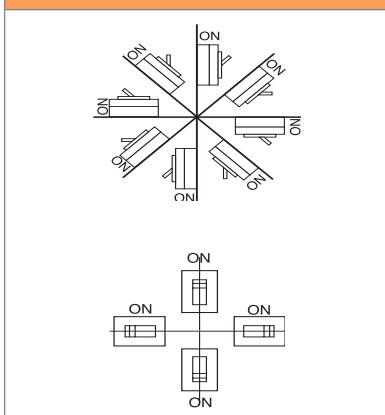

Installation

Minimum distance for NBS 100, 160, 250, 400, 630

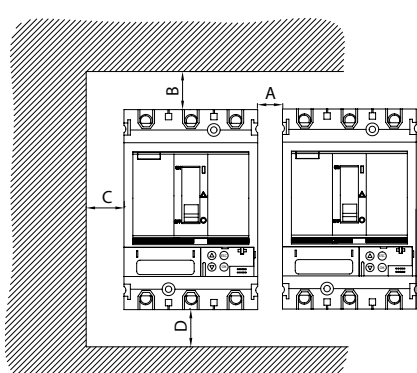

	(mm)
A	0
B	30
C	5
D	30

Minimum distance for NBS 1600

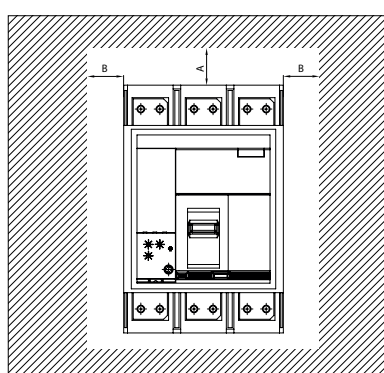

	A	B
	(mm)	
Isolated parts	0	0
Metal parts	120	10
Live parts	180	60

Dimensions NBS-DOS (for Draw-out version ETIBREAK NBS 100-630)

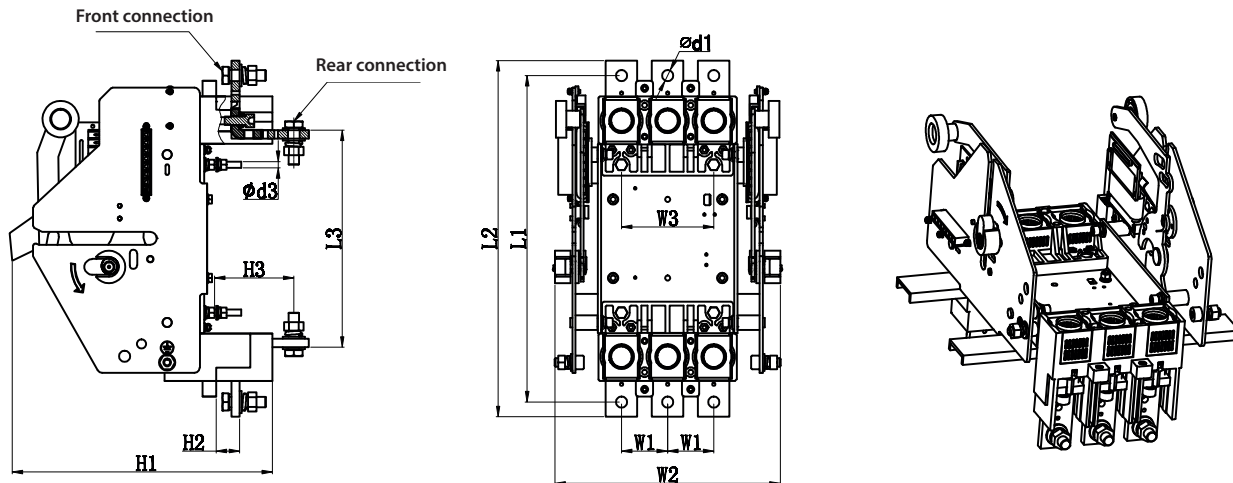

Type	Outline dimensions											Mounting dimensions		
	L1	L2	L3	H1	H2	H3	W1	W2	W3	Ød1	Ød3	A	B	Ød2
NBS-DOS 100-250AF 3P	199	217	124	182	17	40	35	180	70	8,5	M5	68	75	6
NBS-DOS 400-630AF 3P	313	340	206	268	23	85	45	215	90	11	M6	100	150	7

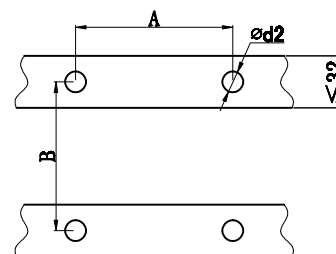

Temperature compensation of time-current characteristics for ETIBREAK NBS

Effect of the ambient temperature on the tripping characteristics  
Calibration temperature is 40°C

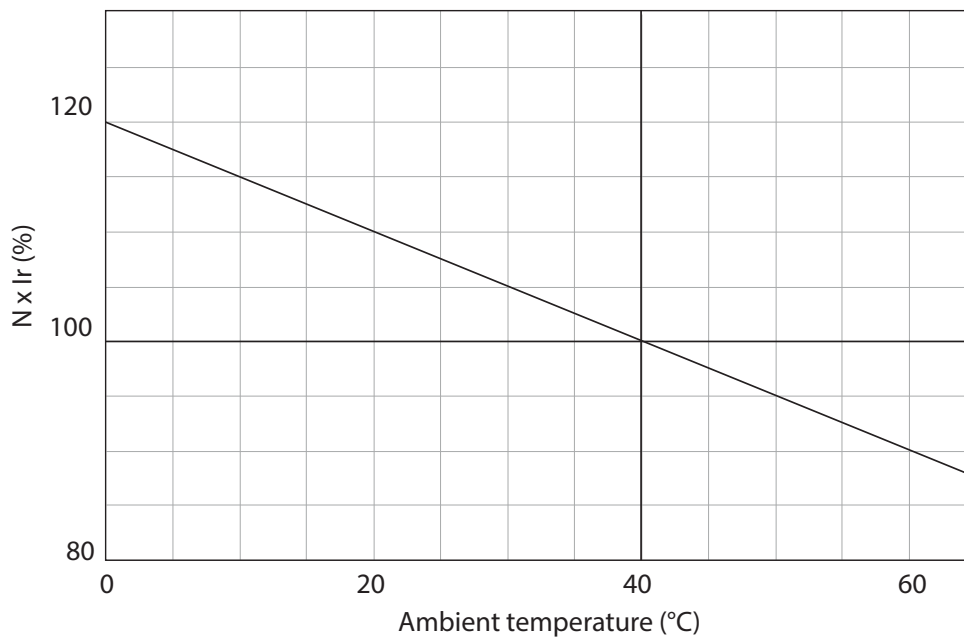

Dimensions ETIBREAK NBS 100, 160, 250

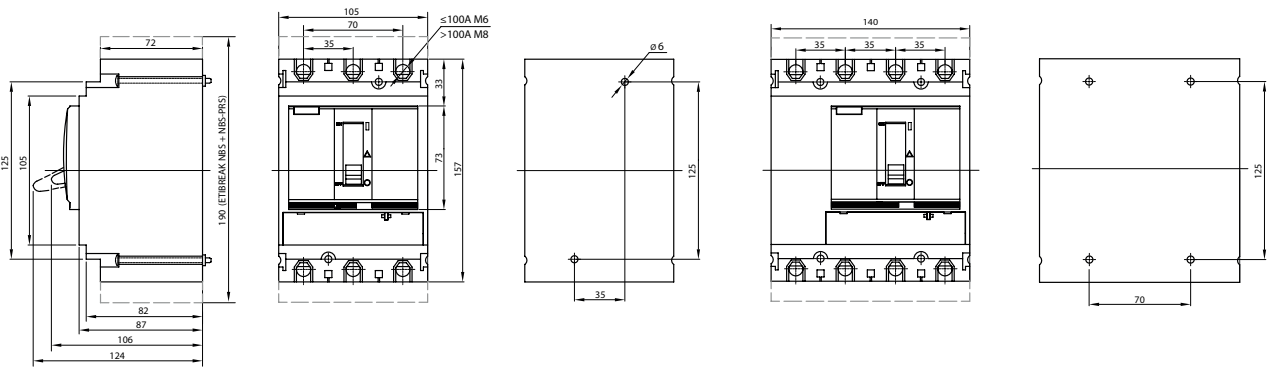

Dimensions ETIBREAK NBS 400, 630

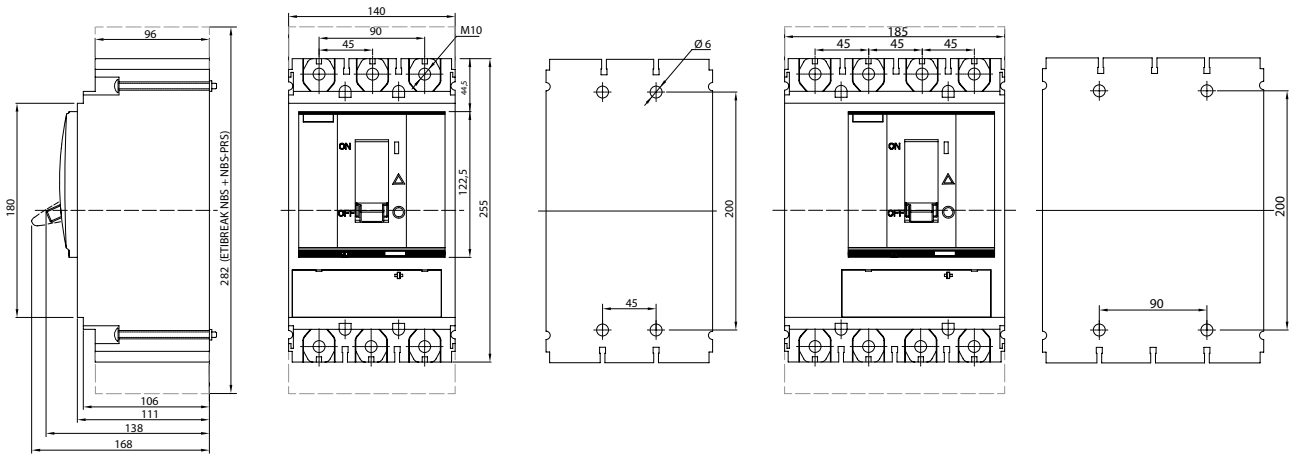

Dimensions ETIBREAK NBS 1600

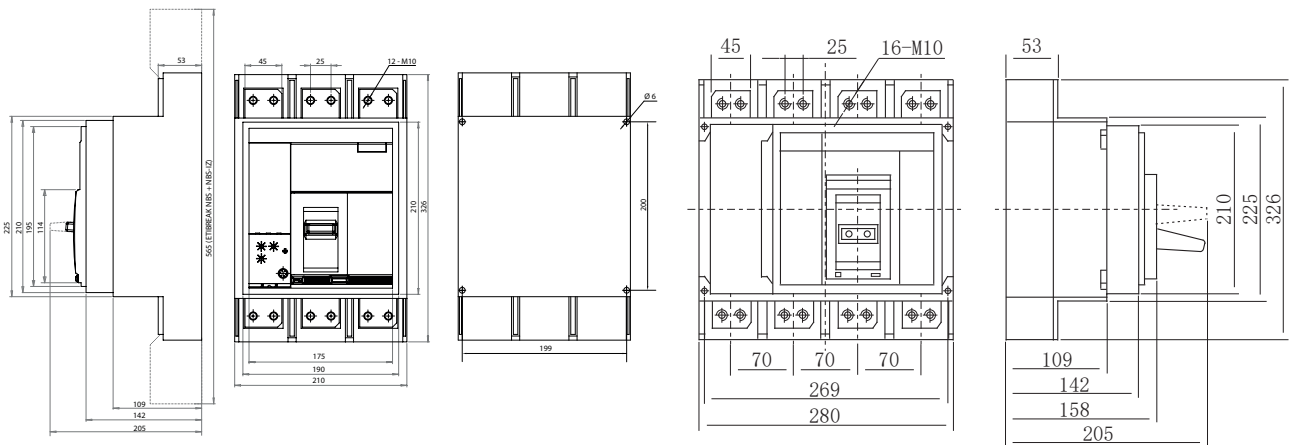



Technical data for low voltage moulded case circuit breakers ETIBREAK NBS

Dimensions NBS-RO 100-250

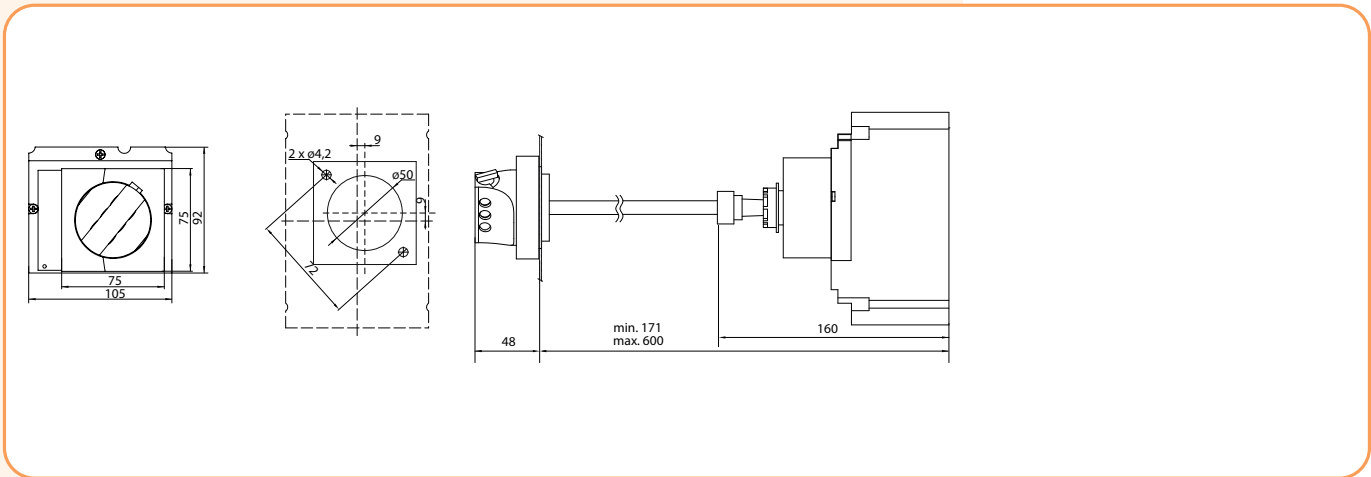

Dimensions NBS-RO 400-630

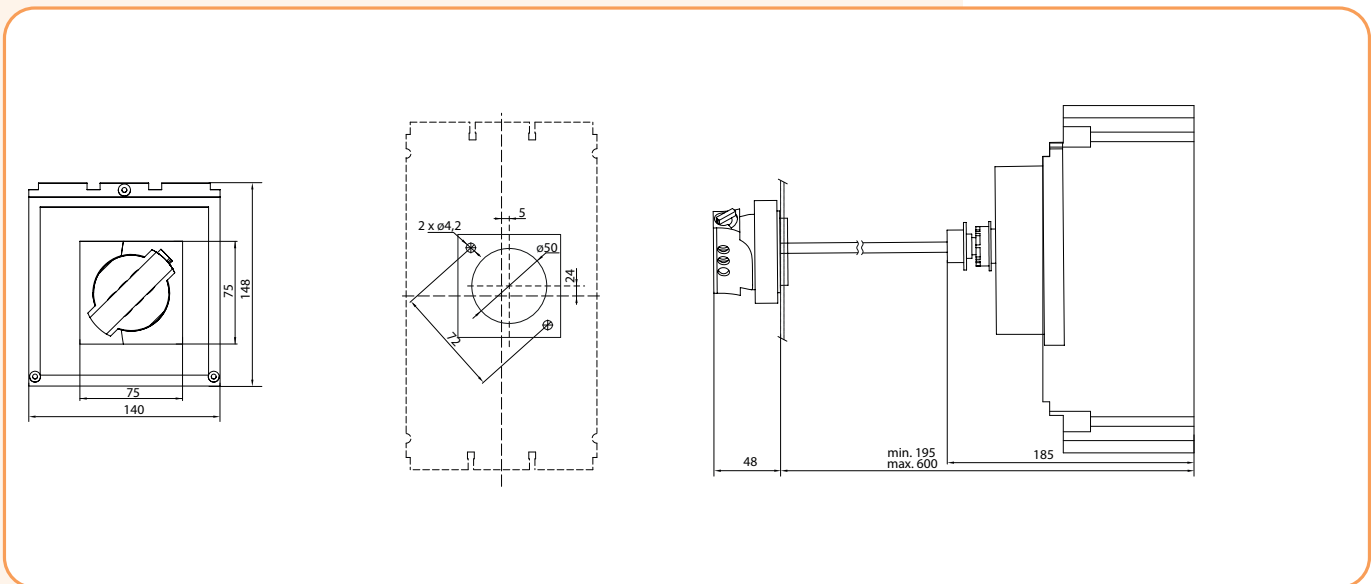

Dimensions NBS-RO 1600

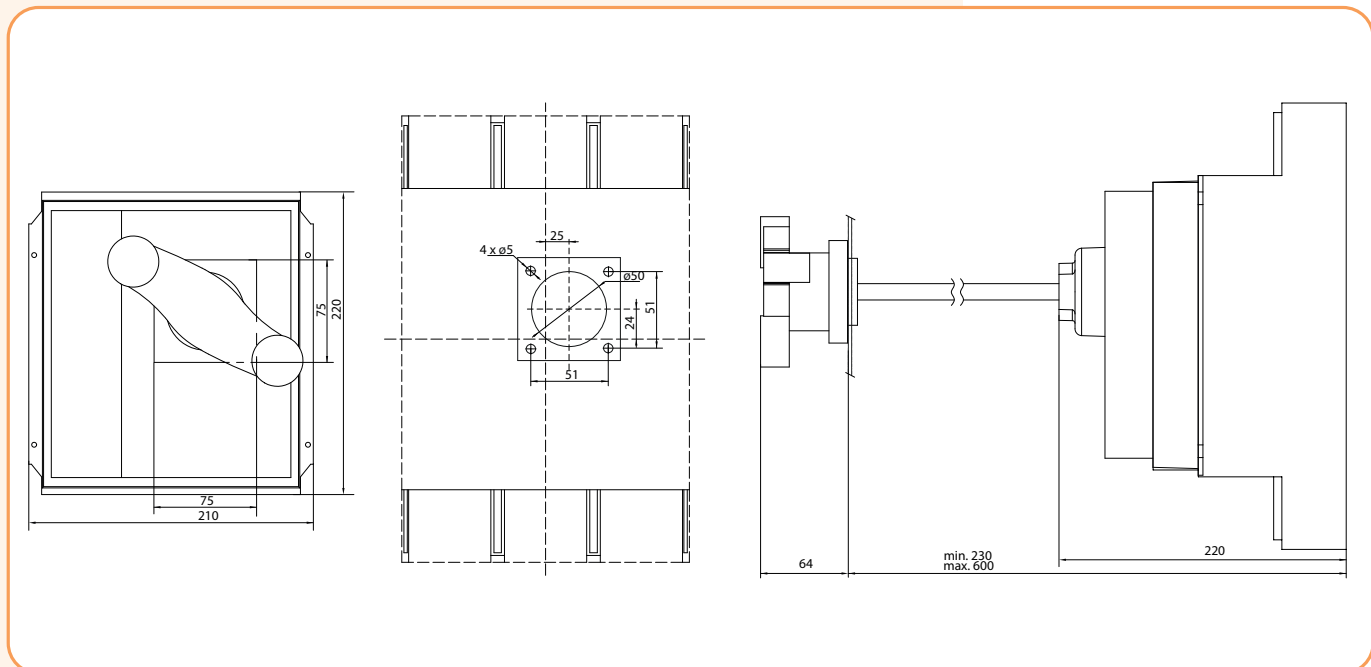

NBS-TMS 100/3 (20A) I/t characteristic

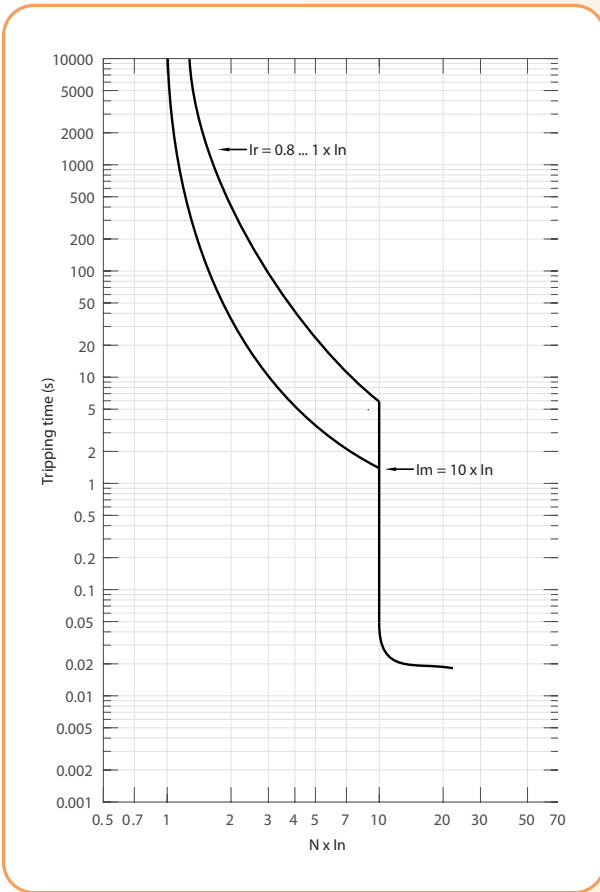

NBS-TMS 100/3 (25A) I/t characteristic

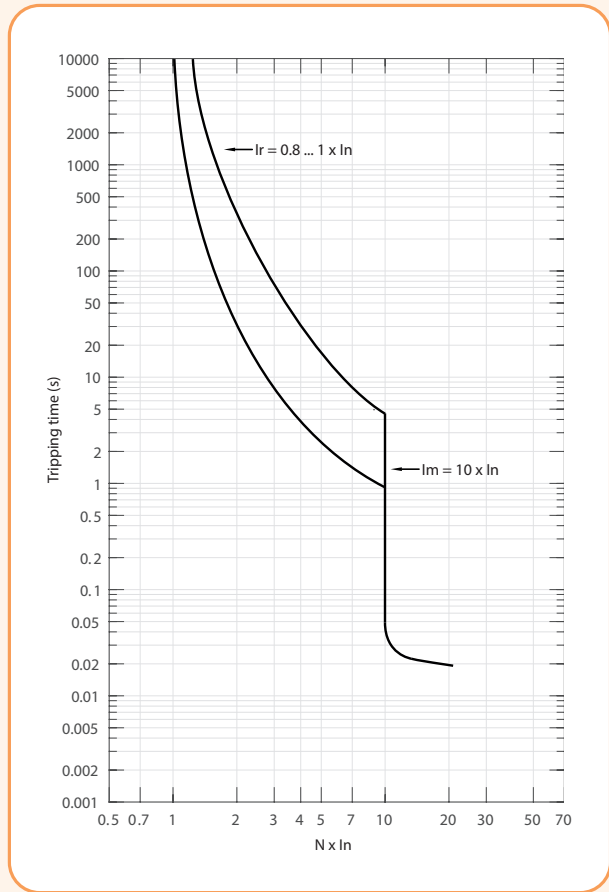

NBS-TMS 100/3 (32, 40A) I/t characteristic

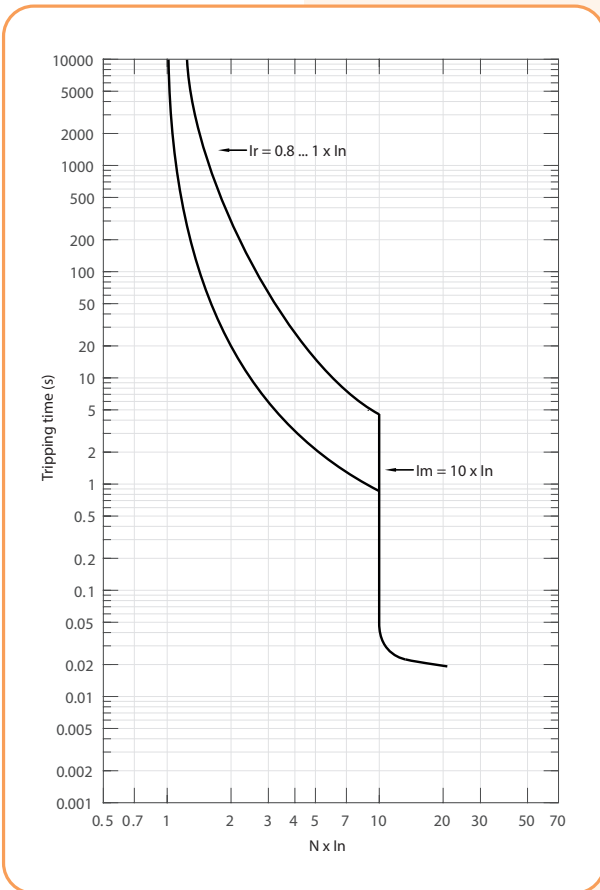

NBS-TMS 100/3 (50, 63A) I/t characteristic

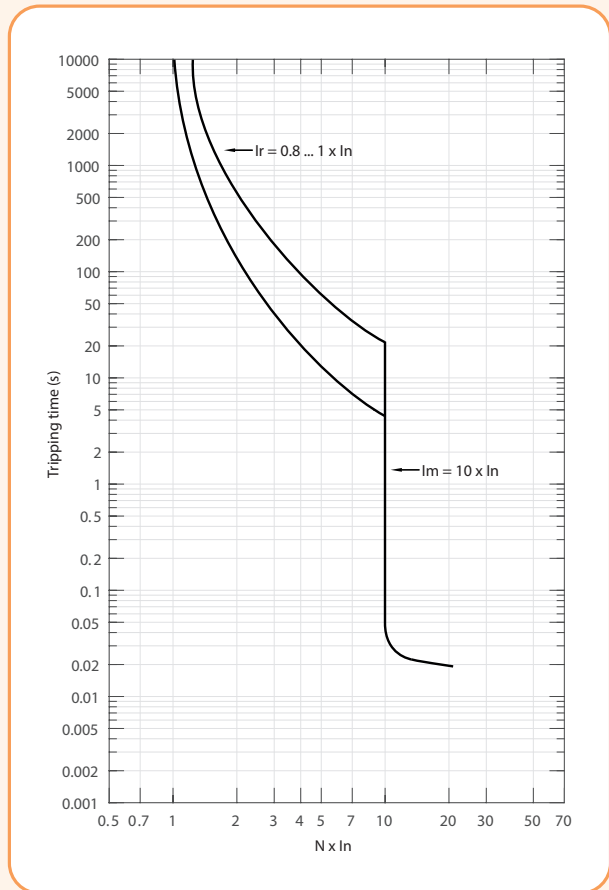

Technical data for low voltage moulded case circuit breakers ETIBREAK NBS

NBS-TMS 100/3 (80, 100A) I/t characteristic

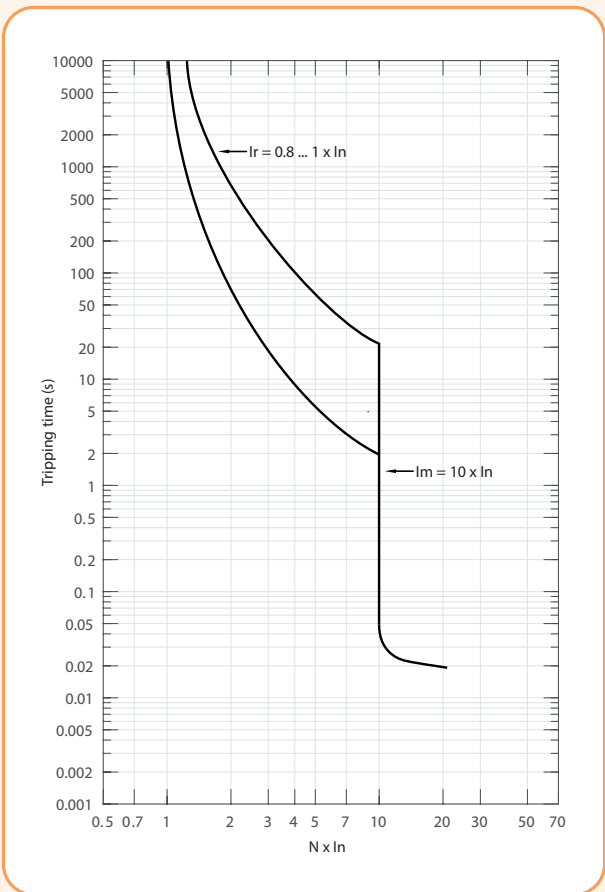

NBS-TMS 160/3 (125, 160A) I/t characteristic

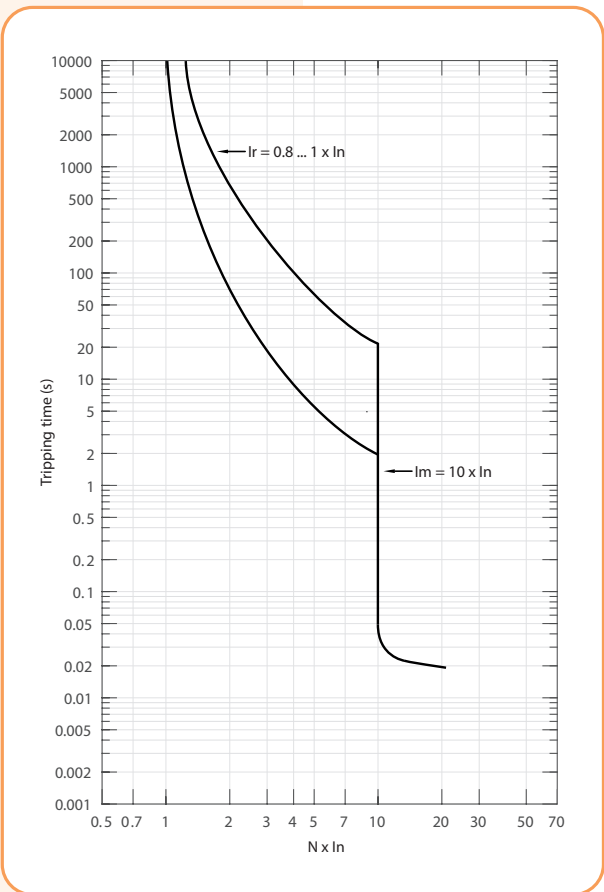

NBS-TMD 250/3 (200, 250A) I/t characteristic

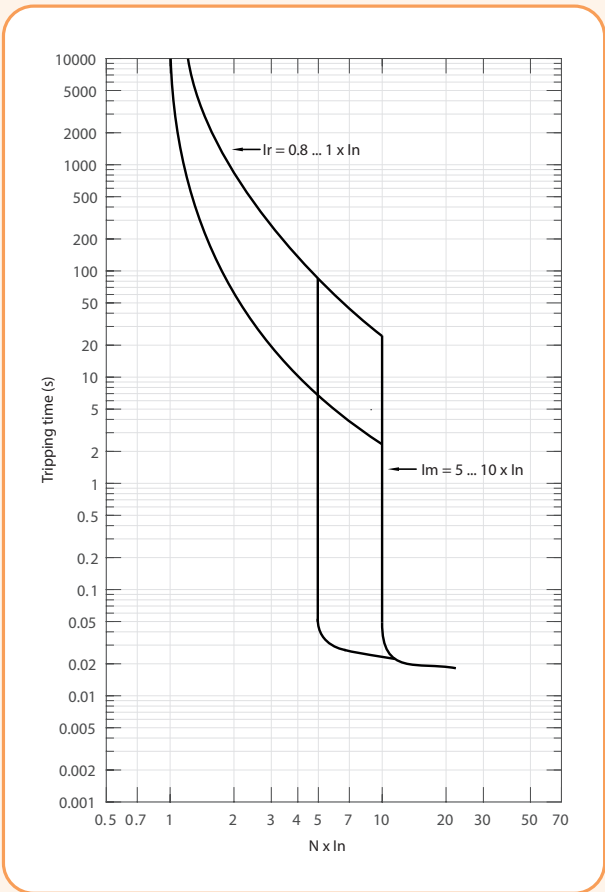

NBS-TMD 400/3 (315, 400A) I/t characteristic

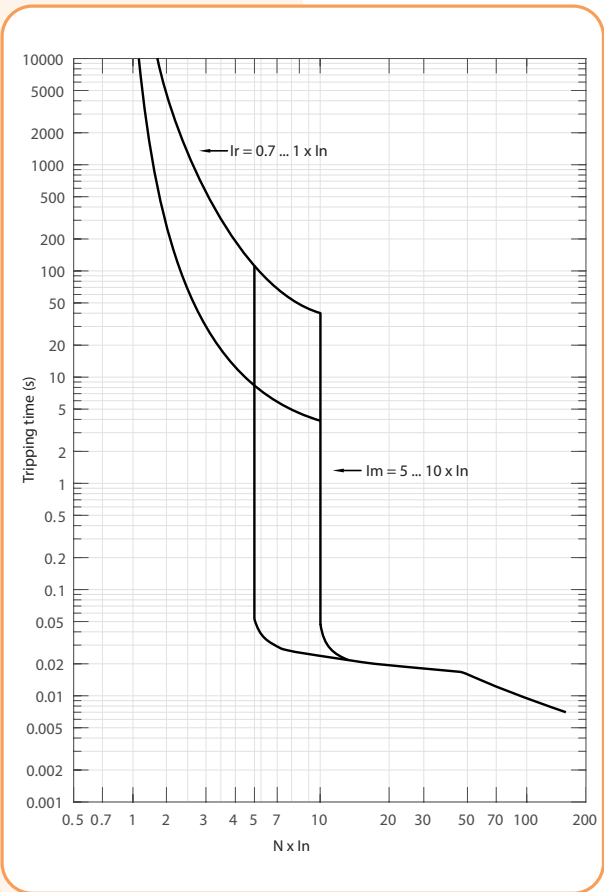

NBS-TMD 630/3 (500, 600A) I/t characteristic

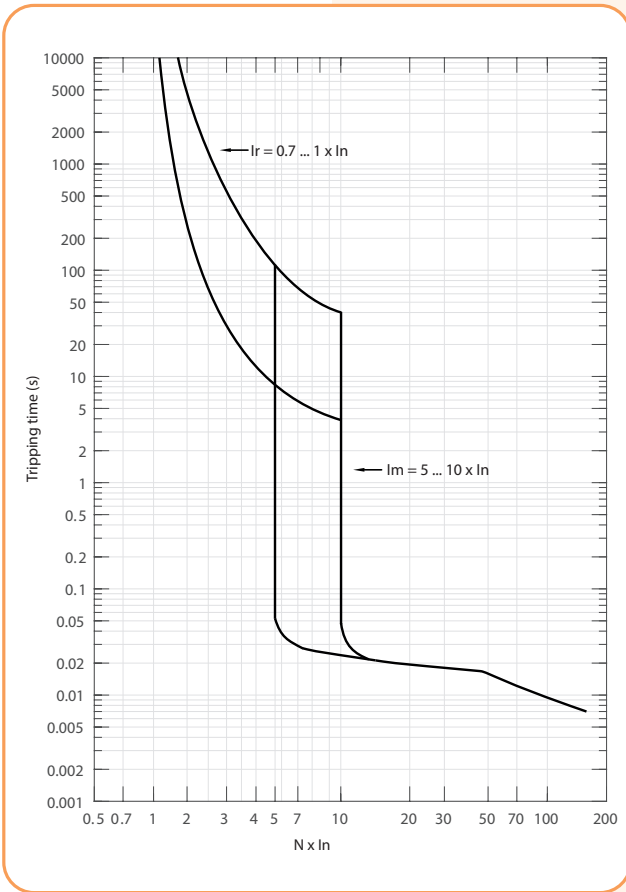

NBS-E (100 - 630A) I/t characteristic

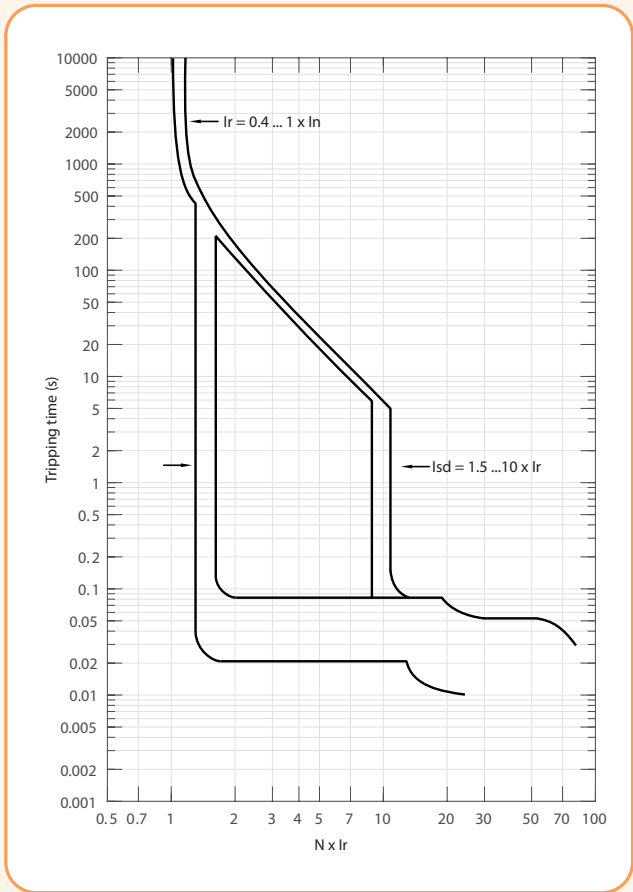

NBS-E (800 - 1600A) I/t characteristic

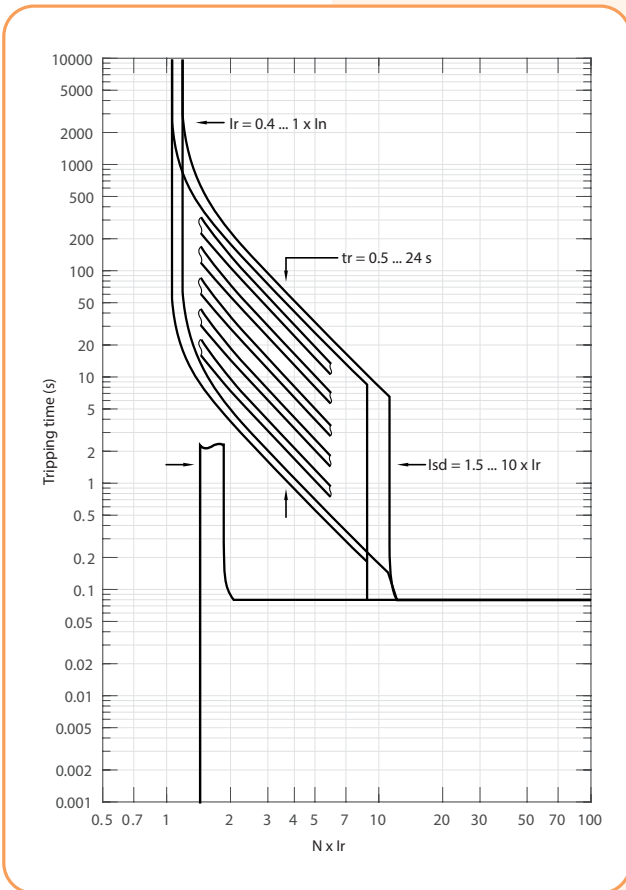

NBS-E&EC LCD (100 - 630A) I/t characteristic

